

# JVC®

## LCD Television Users Guide

# LT-19A200

19" class (18.5" Diagonal)



### Important Note:

In the spaces below, enter the model and serial number of your television (located at the rear of the television cabinet). Staple your sales receipt or invoice to the inside cover of this guide. Keep this user's guide in a convenient place for future reference. Keep the carton and original packaging for future use.

**Model No:** \_\_\_\_\_

**Serial Number:** \_\_\_\_\_

## ✓ **Precautions**

**WARNING:** TO REDUCE THE RISK OF FIRE OR ELECTRIC SHOCK, DO NOT EXPOSE THIS APPARATUS TO RAIN OR MOISTURE. APPARATUS SHALL NOT BE EXPOSED TO DRIPPING OR SPLASHING AND NO OBJECTS FILLED WITH LIQUIDS, SUCH AS VASES, SHALL BE PLACED ON THE APPARATUS.



**CAUTION**  
**RISK OF ELECTRIC SHOCK**  
**DO NOT OPEN**



**CAUTION:** TO REDUCE THE RISK OF ELECTRIC SHOCK, DO NOT REMOVE COVER (OR BACK). NO USER SERVICEABLE PARTS INSIDE. REFER SERVICING TO QUALIFIED SERVICE PERSONNEL.



The lightning flash with arrowhead symbol, within an equilateral triangle, is intended to alert the user to the presence of uninsulated "dangerous voltage" within the apparatus's enclosure that may be of sufficient magnitude to constitute a risk of electric shock to persons.



The exclamation point within an equilateral triangle is intended to alert the user to the presence of important operating and maintenance (servicing) instructions in the literature accompanying the apparatus.

The caution marking is located on the rear or bottom of the cabinet.

## Important Safety Instructions

1. Read these instructions.
2. Keep these instructions.
3. Heed all warnings.
4. Follow all instructions.
5. Do not use this apparatus near water.
6. Clean only with dry cloth.
7. Do not block any ventilation openings. Install in accordance with the manufacture's instructions.
8. Do not install near any heat sources such as radiators, heat registers, stoves, or other apparatus (including amplifiers) that produce heat.
9. Do not defeat the safety purpose of the polarized or grounding-type plug. A polarized plug has two blades with one wider than the other. A grounding type plug has two blades and a third grounding prong. The wide blade or the third prong are provided for your safety. If the provided plug does not fit into your outlet, consult an electrician for replacement of the obsolete outlet.
10. Protect the power cord from being walked on or pinched particularly at plugs, convenience receptacles, and the point where they exit from the apparatus.
11. Only use attachments/accessories specified by the manufacturer.
12. Use only with the cart, stand, tripod, bracket, or table specified by the manufacturer, or sold with the apparatus. When a cart is used, use caution when moving the cart/apparatus combination to avoid injury from tip-over.
13. Unplug this apparatus during lightning storms or when unused for long periods of time.
14. Refer all servicing to qualified service personnel. Servicing is required when the apparatus has been damaged in any way, such as power-supply cord or plug is damaged, liquid has been spilled or objects have fallen into the apparatus, the apparatus has been exposed to rain or moisture, does not operate normally, or has been dropped.



Do not place the unit on the furniture that is capable of being tilted by a child and an adult leaning, pulling, standing or climbing on it. A falling unit can cause serious injury or even death.

### **FCC WARNING**

This apparatus may generate or use radio frequency energy. Changes or modifications to this apparatus may cause harmful interference unless the modifications are expressly approved in the manual. The user could lose the authority to operate this apparatus if an unauthorized change or modification is made.

### **RADIO-TV INTERFERENCE**

This apparatus has been tested and found to comply with the limits for a Class B digital device, pursuant to Part 15 of the FCC Rules. These limits are designed to provide reasonable protection against harmful interference in a residential installation. This apparatus generates, uses, and can radiate radio frequency energy and, if not installed and used in accordance with the instructions, may cause harmful interference to radio communications. However, there is no guarantee that interference will not occur in a particular installation. If this apparatus does cause harmful interference to radio or television reception, which can be determined by turning the apparatus off and on, the user is encouraged to try to correct the interference by one or more of the following measures:

- 1) Reorient or relocate the receiving antenna.
- 2) Increase the separation between the apparatus and receiver.
- 3) Connect the apparatus into an outlet on a circuit different from that to which the receiver is connected.
- 4) Consult the dealer or an experienced radio/TV technician for help.

**This Class B digital apparatus complies with Canadian ICES-003.**

This apparatus should not be placed in a built-in installation such as a bookcase or rack unless proper ventilation is provided. Make sure to leave a space of 2.8 inches (7cm) or more around this apparatus.

Disconnect the mains plug to shut off when find trouble or not in use. The mains plug shall remain readily operable.

**CAUTION:** Danger of explosion if battery is incorrectly replaced. Replace only with the same or equivalent type.

**WARNING:** Batteries (battery pack or battery installed) shall not be exposed to excessive heat such as sunshine, fire or the like.

**Hg LAMP IN LCD CONTAINS MERCURY, DISPOSE ACCORDING TO LOCAL, STATE OR FEDERAL LAW.**

**WARNING:** To prevent injury, this apparatus must be securely attached to the floor/wall in accordance with the instructions.

#### **TO AVOID THE HAZARDS OF ELECTRICAL SHOCK AND FIRE**

- Do not handle the AC power cord with wet hands.
- Do not remove this unit's cabinet. Touching parts inside the cabinet could result in electric shock and/or damage to this unit. For service and adjustment inside the cabinet, call a qualified dealer or an authorized service center.
- Do not pull on the AC power cord when disconnecting it from an AC outlet. Grasp it by the plug.
- Do not put your fingers or objects into the unit.

#### **LOCATION AND HANDLING**

- The openings should not be blocked by placing the unit on a bed, sofa, carpet, rug, or other similar surface.
- Do not install the unit near or over a radiator or heat register.
- Do not install the unit in direct sunlight, near strong magnetic fields, or in a place subject to dust or strong vibration.
- Avoid a place with drastic temperature changes.
- Install the unit in a horizontal and stable position. Do not place anything directly on top or bottom of the unit. Depending on your external devices, noise or disturbance of the picture and/or sound may be generated if the unit is placed too close to them. In this case, please ensure enough space between the external devices and the unit.
- Depending on the environment, the temperature of this unit may increase slightly. This is not a malfunction.

#### **NOTE ABOUT RECYCLING**

- This unit's packaging materials are recyclable and can be reused. Please dispose of any materials in accordance with your local recycling regulations.
- Batteries should never be thrown away or incinerated but disposed of in accordance with your local regulations concerning chemical wastes.



#### **✓ Trademark Information**

- HDMI, the HDMI logo and High-Definition Multimedia Interface are trademarks or registered trademarks of HDMI Licensing LLC.
- Manufactured under license from Dolby Laboratories. "Dolby" and the double-D symbol are trademarks of Dolby Laboratories.
- Products that have earned ENERGY STAR® are designed to protect the environment through superior energy efficiency.

## ✓ **Supplied Accessories**

remote control  
(RM-C-2150)



batteries (AA x 2)



Screw for attaching the  
stand x 3 (FPH34120)



- If you need to replace these accessories, please refer to the part No. with the illustrations and call our toll free customer support line found on the cover of this manual.

## ✓ **Attaching the Stand**

You must attach the stand to the unit to have it as a table top unit. Be sure the front and rear of the stand match the proper direction.

- 1 Spread a thick and soft cloth over a table as shown below. Place the main unit face down onto it. Make sure not to damage the screen.
- 2 Align the 2 stand hooks with the two hooks under the bottom of the main unit (shown by arrow ①), then slide the stand in the direction as shown by arrow ② until it stops and the 3 mounting holes are aligned. Make sure not to put the AC power cord between the stand and the unit.
- 3 Drive screws in the 3 threaded holes at the bottom of the stand until they are tight.

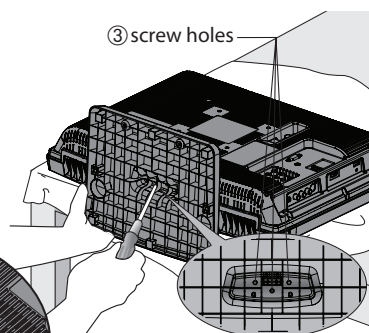
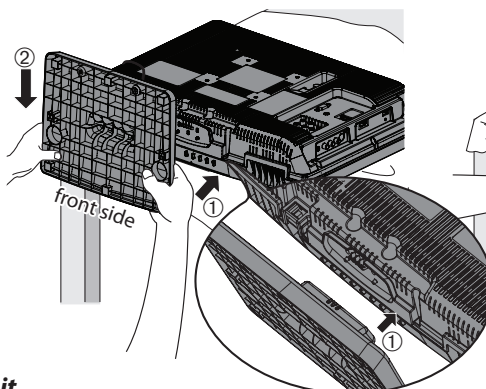
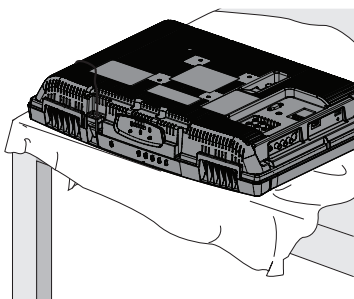

### **To remove the stand from this unit**

Unscrew the screws indicated by above "③"screw holes. After the screws are removed pull the stand up toward the rear of the unit. Be careful not to drop the stand when you remove it.

#### **Note:**

- When attaching the stand, ensure that all screws are tightly fastened. If the stand is not properly attached, it could cause the unit to fall, resulting in injuries as well as damage to the unit.
- Make sure to use a table which can support the weight of this unit and is larger than this unit.
- Make sure the table is in a stable location.

## ✓ **Symbols Used in this Manual**

The following is the description for the symbols used in this manual. Description refers to:

**TV** : Analog TV operation

**DTV** : Digital TV operation

- If neither symbol appears under the function heading, operation is applicable to both.

## ✓ Features

- **DTV/TV/CATV**
  - You can use your remote control to select channels which are broadcast in digital format and conventional analog format. Also, cable subscribers can access their cable TV channels.
- **Information Display (DTV only)**
  - You can display the title, contents and other information of the current DTV program on the TV screen.
- **Autoscan**
  - This unit automatically scans and memorizes channels available in your area, eliminating difficult setup procedures.
- **Child Lock**
  - This feature allows you to block children's access to inappropriate programs.
- **Closed Caption Decoder**
  - Built-in closed caption decoder displays text for closed caption supported programs.
- **MTS/SAP Tuner**
  - Audio can be selected from the remote control.
- **Auto Shut Off Function**
  - If there is no signal input from the antenna terminal and no operation for 15 minutes, the unit will turn off automatically.
- **Sleep Timer**
  - This feature will automatically turn off the power of the unit at a specific time.
- **Choices for On-screen Language**
  - Select your on-screen language: English, Spanish or French.
- **Stereo Sound Function**
- **PLL Frequency Synthesized Tuning**
  - Provides free and easy channel selection and lets you tune directly to any channel using the number buttons on the remote control.
- **Various Adjustment for Picture and Sound**
  - Customizes image quality to suitable for your room and sets the sound as your preference.
- **HDMI Input**
- **Component Video Input**
- **PC Input**
- **S-video Input**
- **AV Input**
- **Digital Audio Output**
- **Headphone Audio Output**

## ✓ Contents

Precautions .....	2
Trademark Information.....	3
<b>INTRODUCTION</b>	
Supplied Accessories.....	4
Attaching the Stand.....	4
Symbols Used in this Manual.....	4
Features.....	5
Control Panel .....	6
Terminals .....	6
Remote Control Function .....	7
Installing the Batteries.....	7
<b>PREPARATION</b>	
Antenna Connection.....	8
Connection to Cable Receiver or Satellite Box .....	8
External Device Connection.....	9
Plug In the AC Power Cord .....	12
Initial Setup .....	13
<b>WATCHING TV</b>	
Channel Selection.....	14
Volume Adjustment.....	14
Sleep Timer .....	14
Still Mode .....	15
Switching Each Input Mode .....	15
Switching Audio Mode.....	15
TV Screen Information.....	16
TV Screen Display Mode.....	17
<b>OPTIONAL SETTING</b>	
Main Menu.....	18
Autoscan.....	18
Channel List.....	19
Manual Register.....	19
Antenna Confirmation .....	20
Language Selection .....	20
Picture Adjustment .....	21
Sound Adjustment.....	22
Closed Caption.....	23
Child Lock.....	26
PC Settings.....	30
Energy Saving Mode .....	31
Location .....	31
Current Software Info .....	32
<b>TROUBLESHOOTING</b>	
FAQ.....	33
Troubleshooting Guide .....	34
<b>INFORMATION</b>	
Glossary.....	36
Maintenance.....	36
Cable Channel Designations .....	37
General Specifications.....	37
Electrical Specification .....	37
Other Specifications.....	37
Limited Warranty.....	Back Cover

✓ **Control Panel**

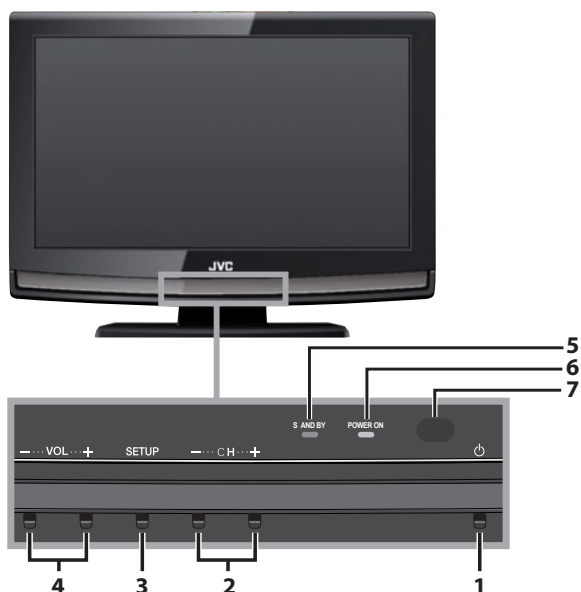

1. **⏻ (power)** (p. 15)  
Press to turn the unit on and off.
2. **CH - / +** (p. 16 / p. 17)  
Press to select channels or move up (+) / down (-) through the main menu items.
3. **SETUP** (p. 15 / p. 44)  
Press to display the main menu.
4. **VOL - / +** (p. 16)  
Press to adjust the volume or move right (+) / left (-) through the main menu items.
5. **STAND BY indicator**  
Lights up red when power is off.
6. **POWER ON indicator**  
Lights up blue when power is on.
7. **infrared sensor window**  
Receives infrared rays transmitted from the remote control.

✓ **Terminals**

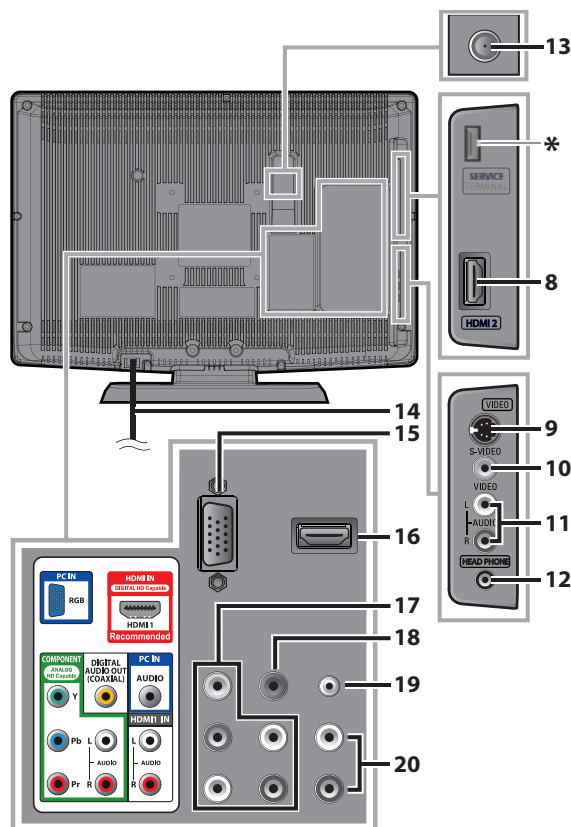

[Side Panel]

8. **HDMI 2 input jack** (p. 8 / p. 9)  
HDMI connection from HDMI device.
9. **S-video input jack** (p. 10)  
S-video cable connection from an external device.
10. **video input jack** (p. 11)  
RCA video cable connection from an external device.
11. **audio input jack** (p. 10 / p. 11)  
RCA audio cable connection from an external device.
12. **headphone jack**  
Headphone connection for personal listening.

[Rear Panel]

13. **antenna input jack** (p. 8)  
RF coaxial cable connection for your antenna or cable TV signal.
14. **AC power cord** (p. 12)  
Connect to a standard AC outlet to supply power to this unit.
15. **PC input jack** (p. 12)  
VGA cable connection for PC.
16. **HDMI 1 input jack** (p. 8 / p. 9)  
HDMI connection for HDMI or DVI device.
17. **component video and audio input jack** (p. 8 / p. 10)  
RCA component video cable and RCA audio cable connection from an external device.
18. **digital audio output jack** (p. 11)  
Coaxial digital cable connection for a decoder or an audio receiver.
19. **audio input jack for PC connection** (p. 12)  
Mini-plug audio cable connection for PC.
20. **audio input jack for HDMI 1** (p. 9)  
RCA audio cable connection from a DVI device.  
(For HDMI 1 input jack only)

**Note:**

\* **service terminal (service use only)**

- User should not connect any devices to the service terminal such as digital camera, keyboard, mouse, etc. (because these will not work).

## ✓ Remote Control Function

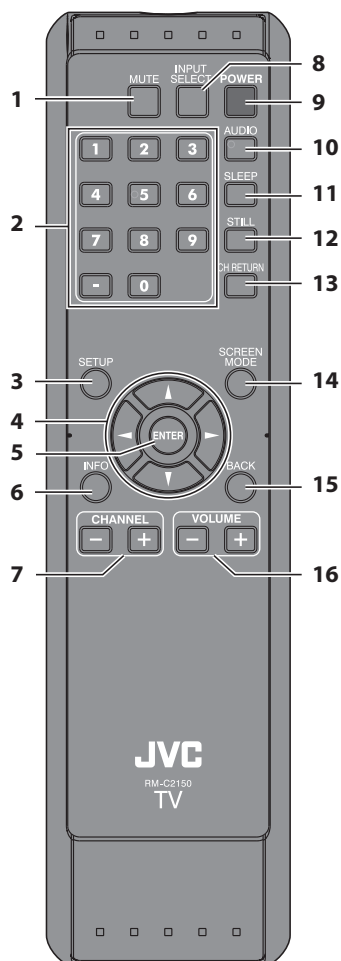

1. **MUTE** (p. 14)  
Press to turn the sound on and off.
2. **Number buttons** (p. 14)
  - Press to select channels.
  - (**hyphen**)
  - Press to shift the subchannel from the main channel.
3. **SETUP** (p. 13)  
Press to display the main menu.
4. **◀/▶ / ▲/▼** (p. 13)  
Press to move left / right / up / down through the items.
5. **ENTER** (p. 13)  
Press to decide the command of setting when the main menu is displayed.
6. **INFO** (p. 16)
  - Digital mode (DTV)**
  - Press to display the channel information, signal type and TV setting.
  - Analog mode (TV)**
  - Press to display the channel number, signal type and TV setting.
  - External input mode**
  - Press to display the external input mode, signal type and TV setting.
7. **CHANNEL – / +** (p. 15)  
Press to select channels and the external input mode.
8. **INPUT SELECT** (p. 15)  
Press to access connected external devices like a BD/DVD recorder.
9. **POWER** (p. 13)  
Press to turn the unit on and off.
10. **AUDIO** (p. 15)
  - Digital mode (DTV)**
  - Press to select the audio language.
  - Analog mode (TV)**
  - Press to select the audio mode.
11. **SLEEP** (p. 14)  
Press to activate the sleep timer.
12. **STILL** (p. 15)  
Press to pause screen image.
13. **CH RETURN** (p. 14)  
Press to return to previously viewed channel.
14. **SCREEN MODE** (p. 17)  
Press to select aspect ratio available for the TV screen.
15. **BACK** (p. 16)  
Press to return to the previous menu operation.
16. **VOLUME – / +** (p. 14)  
Press to adjust the volume.

## ✓ Installing the Batteries

Install the batteries (AA x 2) matching the polarity indicated inside battery compartment of the remote control.

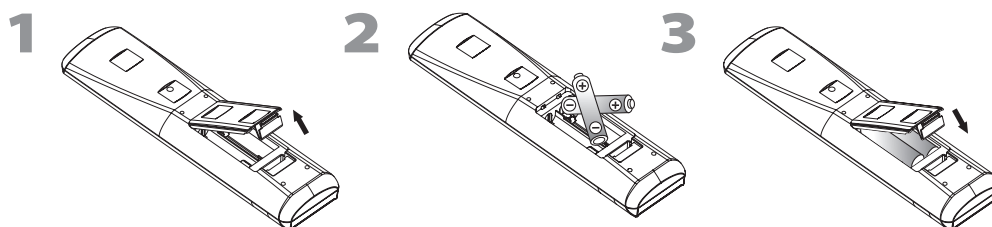

### Battery Precautions:

- Be sure to follow the correct polarity as indicated in the battery compartment. Reversed batteries may cause damage to the device.
- Do not mix different types of batteries together (e.g., Alkaline and Carbon-Zinc, or rechargeable batteries like ni-cad, ni-mh, etc) or old batteries with fresh ones.
- If the device is not to be used for a long period of time, remove the batteries to prevent damage or injury from possible battery leakage.
- Do not try to recharge batteries; they can overheat and rupture.



## No supplied cables are used in this connection:

Please purchase the necessary cables at your local store.  
High Speed HDMI cable (also known as HDMI category 2 cable) is recommended for the better compatibility.

### Before you connect...

**Be sure your antenna or other device is connected properly before plugging in the AC power cord.**

## Antenna Connection

Connect the RF coaxial cable on your home outlet to the antenna input jack of this unit.

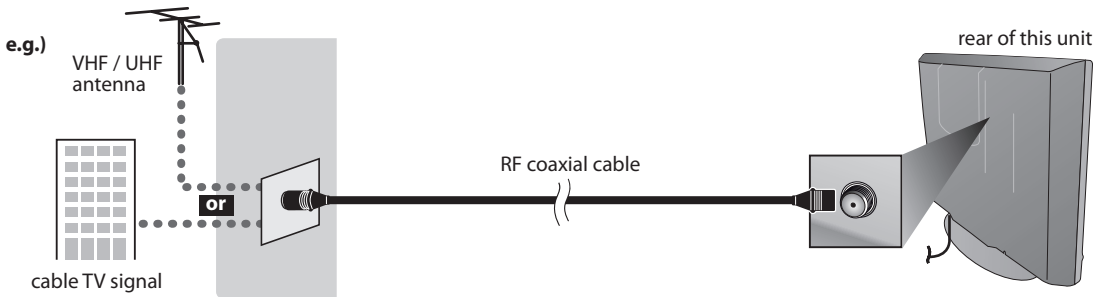

\* Once connections are completed, turn on the unit and begin initial setup. Channel scanning is necessary for the unit to memorize all available channels in your area. (Refer to "Initial Setup" on page 13.)

### Note:

- If you have any question about the DTV's antenna, visit [www.antennaweb.org](http://www.antennaweb.org) for further information.
- Depending on your antenna system, you may need different types of combiners (mixers) or separators (splitters). Contact your local electronics store for these items.
- For your safety and to avoid damage to this unit, please unplug the RF coaxial cable from the antenna input jack before moving the unit.
- If you use an antenna to receive analog TV, it should also work for DTV reception. Outdoor or attic antennas will be more effective than settop versions.
- To switch your reception source easily between antenna and cable, install an antenna selector.
- If you connect to the cable system directly, contact the CATV installer.

## Connection to Cable Receiver or Satellite Box

Use an HDMI or an RCA component video cable to connect the HDMI or the component video input jack of the unit to the HDMI or the component video output jack of the cable receiver / satellite box.

If you connect to the unit's component Video Input jack, connect RCA audio cables to the Audio L/R jacks below the Component Video connector.

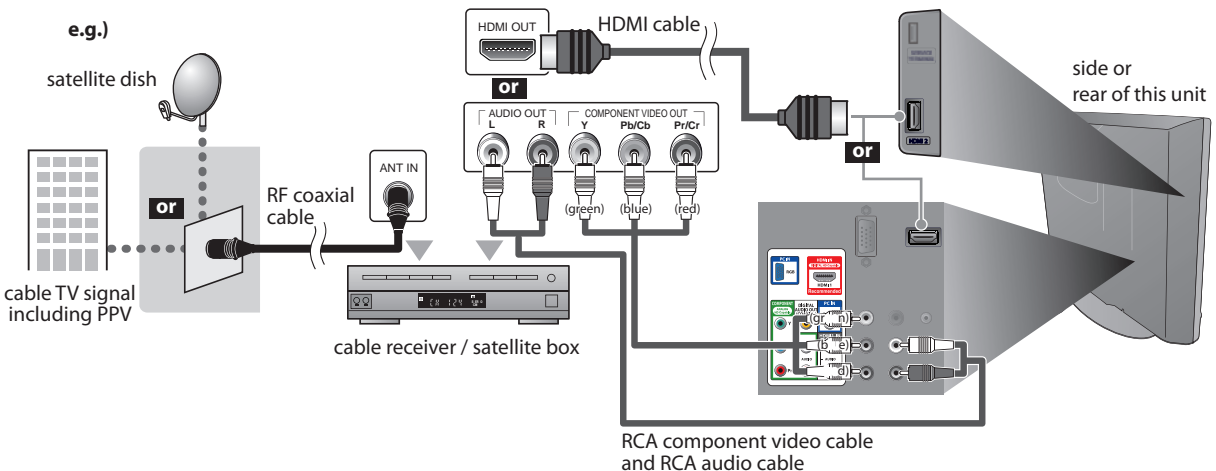

- \* You can also connect this unit to the cable receiver or satellite box other than the HDMI or the component video output jack because they might have different output jacks.
- \* Required cables and connecting methods of the cable receiver / satellite box, or the availability channel for the clear QAM may differ depending on the cable / satellite provider. For more information, please contact your cable / satellite provider.



**No supplied cables are used in this connection:**

Please purchase the necessary cables at your local store.  
High Speed HDMI cable (also known as HDMI category 2 cable) is recommended for the better compatibility.

**External Device Connection****[HDMI Connection]**

HDMI connection offers the highest picture quality.

HDMI (High-Definition Multimedia Interface) transports high definition video and multi-channel digital audio through a single cable.

HDMI CEC (Consumer Electronics Control) allows the TV to connect and control multiple HDMI CEC enabled devices with a single remote. CEC (Consumer Electronics Control) is an optional protocol used in HDMI.

- HDMI CEC on this TV is compliant with "High-Definition Multimedia Interface Specification".
- The TV does not support HDMI CEC functions that are not listed below.
- The TV does not guarantee to support use of all HDMI CEC enabled devices.
- Devices that are not enabled to HDMI CEC cannot be controlled with this TV.

■ Control the TV using the HDMI CEC enabled device

- Turn the TV on and switch to the video source of the operating device.
- Switch to the video source of the operating device.

■ Control the HDMI CEC enabled device using the TV

- Turn off the operating device by pressing the power button for three seconds or more, and turning off the TV.
- \* Some device may not support this function. For more details refer to the device's manual.

■ Send status of the TV to the HDMI CEC enabled device

- When switching the TV's external input or channel.
- When switching the TV's menu language.
- \* Information regarding behaviour of the device when status is received, refer to the external device's manual.

e.g.)

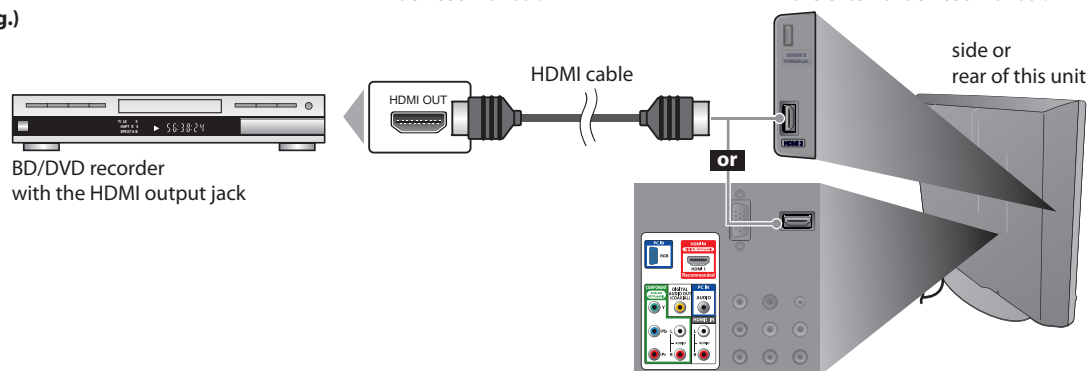
**Note:**

- This unit accepts 480i / 480p / 720p / 1080i video signals, and 32kHz / 44.1kHz / 48kHz audio signals.
- This unit accepts only 2 channel audio signal (LPCM).
- You need to select "PCM" for the digital audio output of the device you connected or check the HDMI audio setting. There may be no audio output if you select "Bitstream", etc.
- This unit only accepts signals in compliance with EIA861.

**[HDMI-DVI Connection]**

Use an HDMI-DVI conversion cable to connect the unit to external video devices equipped with DVI output jack.

e.g.)

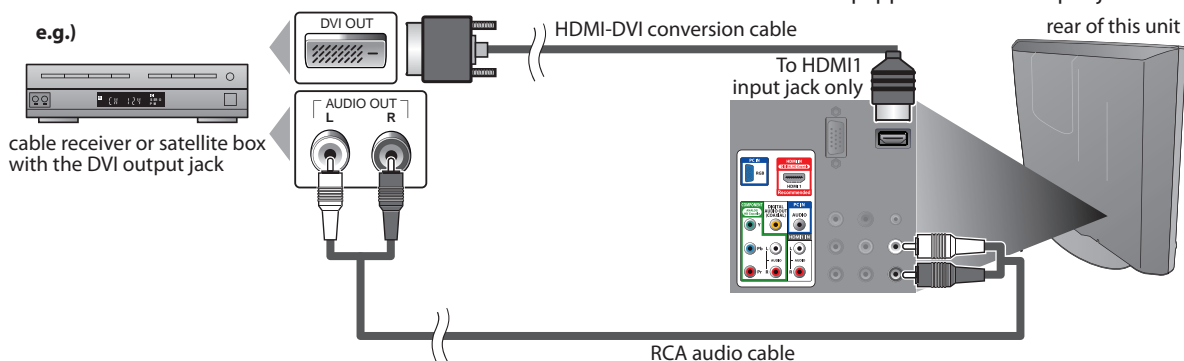
**Note:**

- This unit accepts 480i / 480p / 720p / 1080i video signals.
- HDMI-DVI connection requires separate RCA audio connections as well.
- Audio signals are converted from digital to analog for this connection.
- DVI does not display 480i image that is not in compliance with EIA/CEA-861/861B.

**No supplied cables are used in this connection:**

Please purchase the necessary cables at your local store.

**[Component Video Connection]**

RCA component video connection offers better picture quality for video devices connected to the unit.

If you connect to the unit's component Video Input jack, connect RCA audio cables to the Audio L/R jacks below the Component Video Connector.

e.g.)

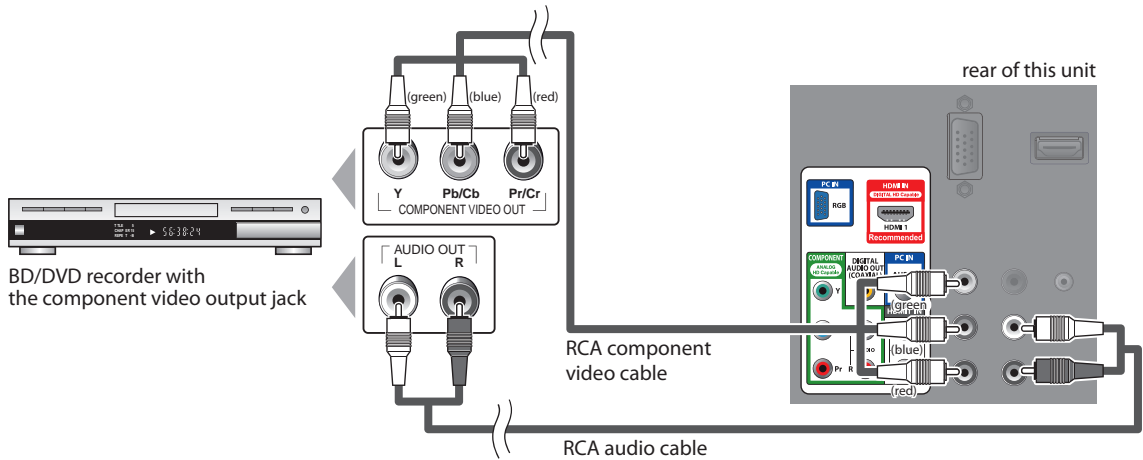

**Note:**

• This unit accepts 480i / 480p / 720p / 1080i video signals.

**[S-video Connection]**

S-video connection offers good picture quality for video devices connected to the unit.

If you connect to the unit's S-Video Input jack, connect RCA audio cables to the Audio L/R jacks below the Video connector.

e.g.)

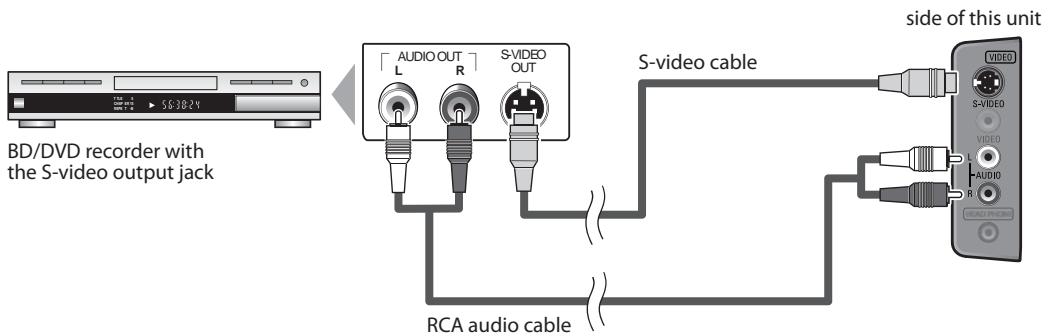

**Note:**

• If you connect to the S-video input jack and the video input jack at the same time, the S-video connection will have priority.

**No supplied cables are used in this connection:**

Please purchase the necessary cables at your local store.

**[Video Connection]**

RCA video connection offers standard picture quality for video devices connected to the unit.

If you connect to the unit's Video Input jack, connect RCA audio cables to the Audio L/R jacks below the Video connector.

When the audio jack of the video device is monaural, connect an RCA audio cable to the audio L input jack.

e.g.)

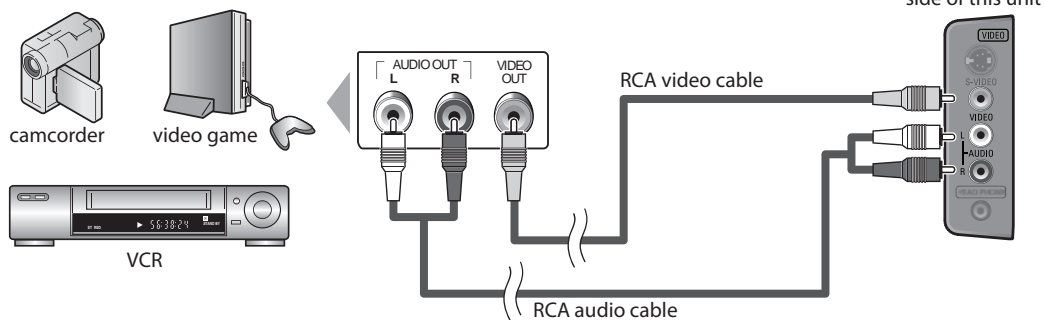
**Note:**

- If you connect to the S-video input jack and the video input jack at the same time, the S-video connection will have priority.

**[Audio Output Connection (for digital broadcasting only)]**

If you connect this unit to an external digital audio device, you can enjoy multi-channel audio like 5.1ch digital broadcasting sound.

Use a digital audio coaxial cable to connect the unit to external digital audio devices.

e.g.)

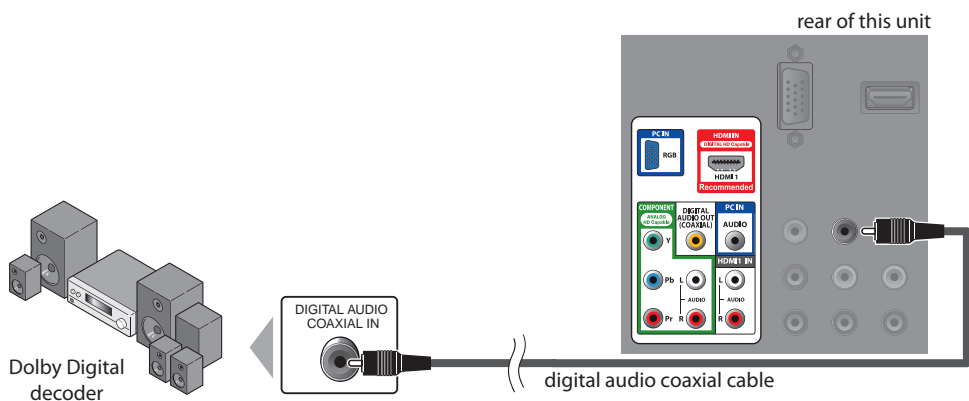

## No supplied cables are used in this connection:

Please purchase the necessary cables at your local store.

### [PC Connection]

This unit is equipped with a PC input jack. If you connect this unit to your PC, you can use this unit as a PC monitor. Use an VGA cable for this connection and it requires stereo mini plug audio cable as well.

e.g.)

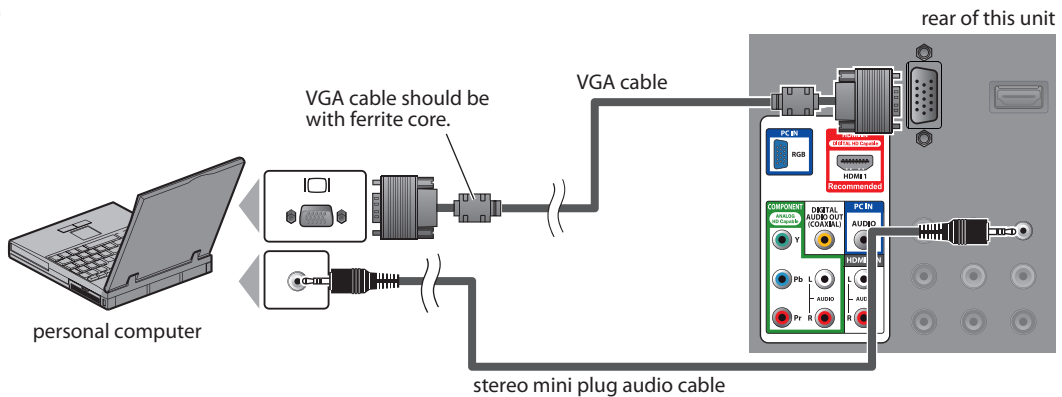

The following signals can be displayed:

Format	Resolution	Refresh rate
VGA	640 x 480	60Hz
SVGA	800 x 600	60Hz
XGA	1,024 x 768	60Hz

Format	Resolution	Refresh rate
WXGA	1,280 x 768	60Hz
	1,360 x 768	60Hz

Other formats or non-standard signals will not be displayed correctly.

#### Note:

- Please purchase the VGA cable that has a ferrite core.
- The following operations may reduce noise.
  - Attach a ferrite core to the AC power cord of your PC.
  - Unplug the AC power cord and use the built-in battery of your PC.

### ✓ Plug In the AC Power Cord

Make sure that the AC power cord must be plugged to an AC outlet after all the necessary connections are completed.



#### Caution:

- Do not connect the AC power cord to a power supply outside the indicated voltage of this unit (AC 120V). Connecting the AC power cord to a power supply outside of this range may result in fire or electrical shocks.

#### Note:

- Each time you plugged in the AC power cord, any operations will not be performed for a few seconds. This is not a malfunction.

**These operations are accessible by remote control. Some may also be accessible by controls on the main unit.**

## ✓ Initial Setup

This section will guide you through the unit's initial setting which includes selecting a language for your on-screen menu and autoscanning, which automatically scans and memorizes viewable channels.

### Before you begin:

Make sure the unit is connected to antenna or cable.

- After making all the necessary connections, press **[POWER]** to turn on the unit.

**POWER**



- This operation may take a few moments.

- Use **[Cursor ▲/▼]** to select the on-screen language from the choices on the right side of the TV screen. (English / Español / Français)



or



ENTER



- "Initial Setup" menu on step 3 will be displayed in the selected language after you press **[ENTER]**.

- Use **[Cursor ▲/▼]** to select "Antenna" for TV channels or "Cable" for CATV channels, then press **[ENTER]**.



or



ENTER

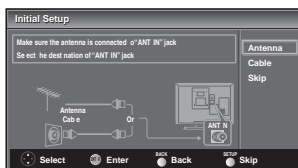

- "Autoscan" will begin.

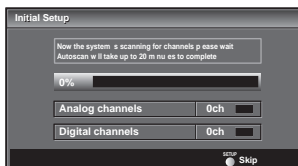

- Use **[Cursor ◀/▶]** to select the desired location setting, then press **[ENTER]**.

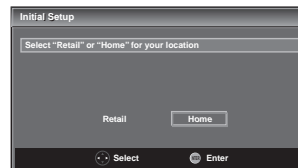
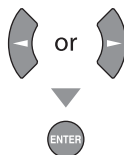

- Select "Retail", the unit will be set up with predefined setting for retail displays. In this setting, the power consumption may possibly exceed the limited requirement of the ENERGY STAR® qualification.
- Select "Home", the unit is set to maximize the energy efficiency for home setting and it can be adjusted through a choice of picture and sound quality according to your preference.
- When the initial setup is completed, the lowest memorized channel with the confirmation message of the location setting will be displayed on the TV screen.

### Note:

- If you connect the cable system directly, contact the CATV installer.
- If you press **[POWER]** or **[SETUP]** during autoscanning, this setting will be canceled.
- The initial autoscanning function can be executed for either "Antenna" or "Cable" only once. When you change the connection (Antenna / Cable), set autoscanning again. (Refer to page 18.)
- If there is no signal input from the antenna terminal and no operation for several seconds after you turn on the unit, "Helpful Hints" appears. Follow the instructions listed on the TV screen.

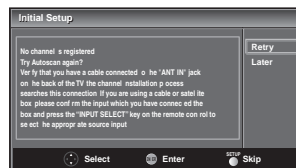

- You must set "Home" in step 4. Otherwise, the settings of picture and sound quality you adjusted will not be memorized after you turn off the unit.

### After an initial setup is completed...

- If you want to scan the channels automatically again, refer to "Autoscan" on page 18.
- You can add the desired channels unmemorized by "Autoscan". Refer to "Manual Register" on page 19.
- If you want to change to another language, refer to "Language Selection" on page 20.
- If you want to change the location setting, refer to "Location" on page 31.

## ✓ Channel Selection

Select channels by using [CHANNEL - / +] or [the Number buttons].

- To select the memorized channels, use [CHANNEL - / +] or [the Number buttons].
- To select the non-memorized channels, use [the Number buttons].

### To Use [the Number buttons]

TV

- When selecting channel 11



DTV

- When selecting digital channel 11-1  
Be sure to press [-] before entering the subchannel number.



- Press [CH RETURN] to return to the previously channel.

### About digital TV broadcasting:

With its high definition broadcast, digital broadcasting far surpasses analog broadcasting in both its picture and sound quality. Not all digital TV broadcasts are high definition (HD). To confirm whether your watching TV program is in HD, refer to the program guide, contact your cable / satellite provider or local TV stations.

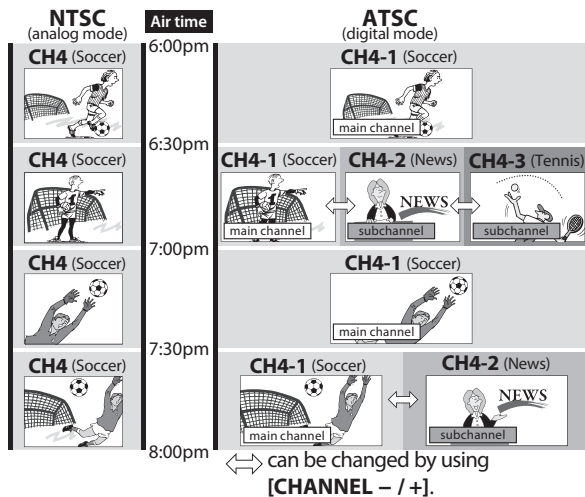

### What is the subchannel?

By using high compression technology, digital broadcasting offers a service that enables multiple signals to send simultaneously. Therefore, you can select more than one program per main channel since digital broadcasting technology distinguishes between multiple channels broadcast by a single network.

#### Note:

- "No Signal" will appear on the TV screen after the subchannel broadcast is over.
- "Audio only program" message will appear on the TV screen, when you receive only sound signal.

## ✓ Volume Adjustment

This section describes how to adjust the volume. The mute function, which turns the sound off and on, is also described.

Use [VOLUME - / +] to adjust the audio volume.

VOLUME



The volume bar will be displayed at the bottom of the TV screen when adjusting the volume.

- The volume bar will automatically disappear in a few seconds.

Press [MUTE] to turn off and on the sound.

MUTE



"Mute" is displayed on the TV screen for a few seconds.

Press [MUTE] again or [VOLUME - / +] to recover the original volume.

## ✓ Sleep Timer

The sleep timer can be set to automatically turn off the unit after an incremental period of time.

- Press [SLEEP] to set the sleep timer.

SLEEP



Sleep timer display appears on the TV screen.

- Press [SLEEP] repeatedly to change the amount of time until shut off.

SLEEP



You can set your unit to turn off after a set period of time (from 30 to 120 minutes).

- Each press of [SLEEP] will increase the time by 30 minutes.
- After setup, the sleep timer display can be called up for checking by pressing [SLEEP].

### To cancel the sleep timer

Press [SLEEP] repeatedly until "Sleep Off" is displayed on the TV screen.

#### Note:

- The sleep timer display will automatically disappear in a few seconds.
- When you disconnect the unit from the AC outlet or when a power failure occurs, the sleep timer setting will be canceled.

## ✓ Still Mode

You can pause the image shown on the TV screen.

Press **[STILL]** to pause the image shown on the TV screen.



- The sound output will not be paused.
- If no signal is detected or protected signal is received during still mode, the image remains paused and the sound output will be muted.
- The still function will be released after 5 minutes.

To cancel still mode, press any button except **[POWER]**.

## ✓ Switching Each Input Mode

You can easily switch with the remote control to the DTV (ATSC) and TV (NTSC) or to access external devices when they are connected to the unit.

Press **[INPUT SELECT]** or **[CHANNEL +]** repeatedly to cycle through the input modes.

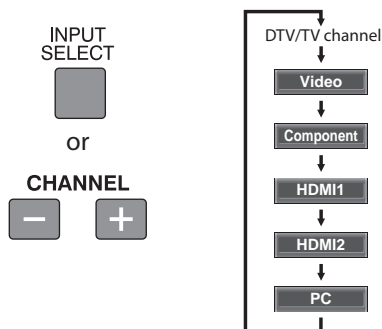

- Pressing **[CHANNEL -]** reverses the direction of the input modes.

## ✓ Switching Audio Mode

This section describes how to switch the audio in the analog mode and how to switch the audio language in the digital mode.

### TV

Press **[AUDIO]** to display the currently selected audio mode. While receiving an MTS broadcast, press repeatedly to cycle through the available audio channel.



When all audio are available



When stereo and monaural audio are available



When SAP and monaural audio are available



When only monaural audio is available



(cannot be switched)

- STEREO** : Outputs stereo-audio
- SAP** : Outputs second audio program
- MONO** : Outputs mono-audio

### DTV

- 1 Press **[AUDIO]** to display the currently selected language and the number of available languages.



- 2 Press **[AUDIO]** repeatedly to cycle through the available audio languages.



- Available languages differ depending on the broadcast. "Other" is displayed when the audio language cannot be acquired, or the acquired languages are other than English, Spanish or French.

### Note:

- **[AUDIO]** does not control external audio devices.
- The information display will automatically disappear in a few seconds.



## ✓ TV Screen Information

You can display the currently selected channel or other information such as the audio mode on the TV screen.

TV

In the analog mode, the current channel number and the audio mode are displayed.

Press **[INFO]**.

INFO

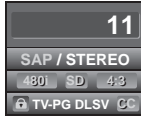

- The current channel number, audio mode, type of resolutions for video signal, TV aspect ratio, CC and TV program rating are displayed on the top-right corner of the TV screen.
- To clear the display, press **[INFO]** again. You can also press **[BACK]**.

DTV

In the digital mode, the detailed broadcasting information for the current channel such as program title, program guides are displayed.

Press **[INFO]** to display the details of the currently selected program.

INFO



### Broadcasting information

The following information is displayed.

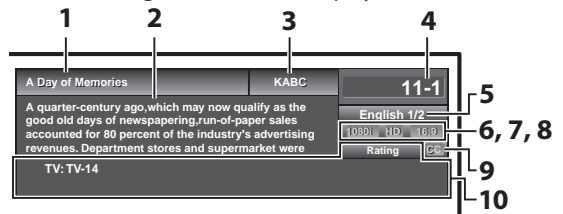

- 1 program title
- 2 program guide  
(The program guide added to broadcasting information is displayed to a maximum of 4 lines.)
- 3 broadcast station
- 4 channel number
- 5 audio language  
(Refer to "Switching Audio Mode" on page 15.)
- 6 effective scanning lines and scan mode
- 7 digital TV format
- 8 program aspect ratio
- 9 CC (not available if closed caption is set to "Off")
- 10 child lock rating

#### Note:

- When the program guide consists of more than 4 lines, use **[Cursor ▲/▼]** to scroll.
- "No description provided." is displayed when the program guide is not provided.
- While the program guide is displayed, the closed caption function is interrupted.
- In external input mode, the following screen is displayed; e.g.) When an external device is connected to VIDEO input jack.

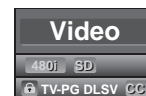

- The information display will automatically disappear in 1 minute.

## ✓ TV Screen Display Mode

4 types of display modes can be selected when the broadcasting station is sending 4:3 or 16:9 video signal. And 3 types of display modes can be selected for PC input signal.

Press [**SCREEN MODE**] repeatedly to switch the TV aspect ratio.

SCREEN  
MODE



### For 4:3 video signal

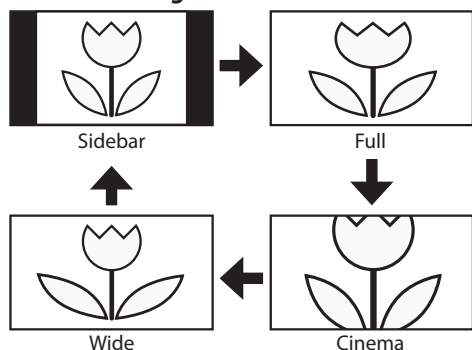

#### Sidebar

Display a 4:3 picture at its original size. Sidebars appear on both edges of the screen.

#### Full

Display a 4:3 picture at a 16:9 size; the picture is stretched horizontally to fill the screen.

#### Cinema

Display a 4:3 picture at a 16:9 size; the picture is stretched horizontally and vertically to fill the screen. This crops out the top and bottom of the picture.

#### Wide

Display the picture with its center at the original size and the edges stretched horizontally to fill the screen.

### For 16:9 video signal

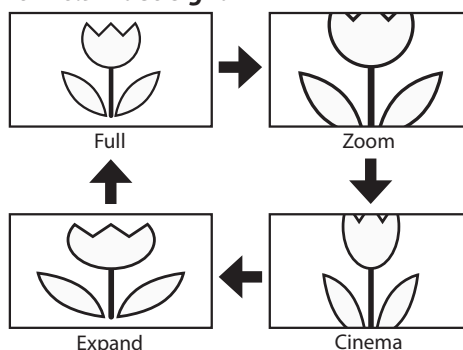

#### Full

Display a 16:9 picture at its original size.

#### Zoom

Display a 16:9 picture at its maximum size without changing its horizontal and vertical ratio.

#### Cinema

Display a vertically stretched picture.

#### Expand

Display a horizontally stretched picture.

### For PC input signal

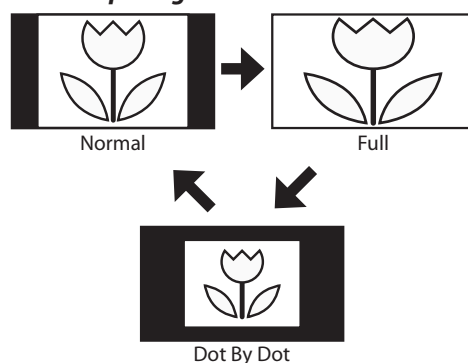

#### Normal

Display a proportionately stretched picture. Sidebars appear on both edges of the screen.

#### Full

Display a picture that is stretched out of proportion to fill the screen.

#### Dot By Dot

Display a picture in its original size.

## ✓ Main Menu

This section describes the overview of the main menu displayed when you press [SETUP]. For more details, see the reference page for each item. The main menu consists of the function setting items below.

Press [SETUP].



### PICTURE

You can adjust the picture quality. (Refer to "Picture Adjustment" on page 21.)

### SOUND

You can adjust the sound quality. (Refer to "Sound Adjustment" on page 22.)

### CHANNEL

- You can automatically scan the viewable channels. (Refer to "Autoscan" on page 18.)
- You can skip the undesired channels when selecting the channels using [CHANNEL - / +]. (Refer to "Channel List" on page 19.)
- You can add the channels that were not scanned by the autoscan. (Refer to "Manual Register" on page 19.)

### DETAIL

- You can change the display format for closed caption, which displays the dialogue of a TV program or other information across the TV screen. (Refer to "Closed Caption" on page 23.)
- You can set the viewing limitations. (Refer to "Child Lock" on page 26.)
- You can adjust the position, stability and clarity of the PC screen. (Refer to "PC Settings" on page 30.)
- You can select the energy saving mode. (Refer to "Energy Saving Mode" on page 31.)
- When you adjust the desired "PICTURE" and "SOUND" mode, you must switch the setting from "Retail" to "Home". (Refer to "Location" on page 31.)
- You can confirm the version of the software currently used in this unit. (Refer to "Current Software Info" on page 32.)

### LANGUAGE

You can change the language (English, Spanish, French) displayed on the main menu. (Refer to "Language Selection" on page 20.)

## ✓ Autoscan

If you switch wires (e.g., between antenna and CATV) or if you move the unit to a different area after the initial setting, or if you restore the DTV channel you deleted, you will need to perform autoscan.

**Before you begin:** Make sure the unit is connected to antenna or cable.

- Press [SETUP] to display the main menu.



- Use [Cursor ▲/▼] to select "CHANNEL", then press [ENTER].

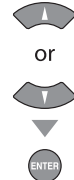

- Use [Cursor ▲/▼] to select "Autoscan", then press [ENTER].

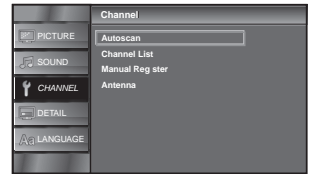
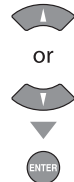

Use [Cursor ▲/▼] to select an appropriate option, then press [ENTER].

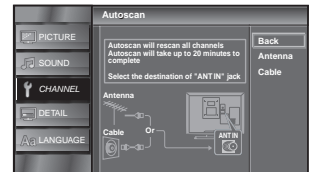

- When aerial antenna is connected, select "Antenna".
- When connected to CATV, select "Cable".
- "Autoscan" will begin.

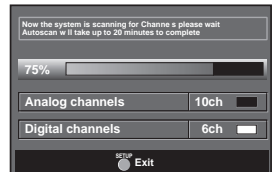

- When the scanning and memorizing are completed, the lowest memorized channel will be displayed.

### Note:

- After setting "Autoscan", using [CHANNEL - / +] on the remote control skips unavailable programs automatically.
- If you connect the cable system directly, contact the CATV installer.
- If you press [POWER] or [SETUP] during autoscan, the setting will be canceled.
- Even if "Autoscan" is completed, the channel setting will be lost if the AC power cord is unplugged before turning off the unit by pressing [POWER].
- The PIN Code will be required once you set a PIN Code in the "Child Lock" (Refer to page 26).
- If you want to change your PIN Code, follow the instruction of "New Password" (Refer to page 29).

## ✓ Channel List

The channels selected here can be skipped when selecting the channels using [CHANNEL -/+]. Those channels can still be selected with [the Number buttons].

1 Press [SETUP] to display the main menu.



2 Use [Cursor ▲/▼] to select "CHANNEL", then press [ENTER].



3 Use [Cursor ▲/▼] to select "Channel List", then press [ENTER].



4 Use [Cursor ▲/▼] to select the channel you want to remove, then press [ENTER].



- The channel display for the removed channel darkens. You will not be able to select the channel again using [CHANNEL -/+].
- To reactivate a removed channel, use [Cursor ▲/▼] and press [ENTER]. The registered channels are highlighted.
- When you remove a main channel, its subchannels are removed as well.

### Note:

- The channel with the "DTV" indicated on the display is ATSC. Otherwise the channel is NTSC.

5 Press [SETUP] to exit.



## ✓ Manual Register

This function lets you add the channels that were not added by the autoscanner due to the receptive condition at the initial setting.

1 Press [SETUP] to display the main menu.



2 Use [Cursor ▲/▼] to select "CHANNEL", then press [ENTER].

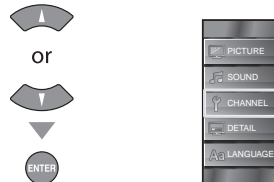

3 Use [Cursor ▲/▼] to select "Manual Register", then press [ENTER].



4 Use [the Number buttons] to enter the number of the channel you want to add, then press [ENTER].

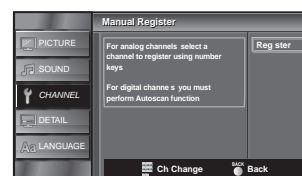
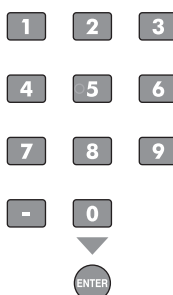

5 Press [SETUP] to exit.



### Note:

- If setup completes successfully, "Added to the channel list" is displayed.
- If external input is used, it is not possible to register the channel and "Unavailable" will be displayed on the TV screen.
- By using [CHANNEL -/+], you can select the memorized channels only.

## Antenna Confirmation

DTV

This function lets you check the digital signal strength of each channel.

1 Press **[SETUP]** to display the main menu.

SETUP



2 Use **[Cursor ▲/▼]** to select "CHANNEL", then press **[ENTER]**.



or



ENTER



3 Use **[Cursor ▲/▼]** to select "Antenna", then press **[ENTER]**.



or



ENTER

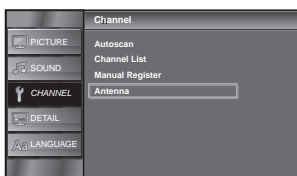

4 Use **[the Number buttons]** or **[CHANNEL -/ +]** to select the channel for which you want to check the digital signal strength.

1 2 3

4 5 6

7 8 9

- 0

OR

CHANNEL

- +

11-1

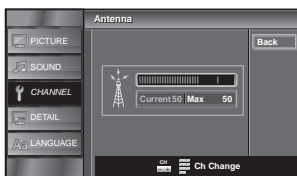

- If the channel is set to analog channel or external input, you cannot confirm the antenna condition.

Video

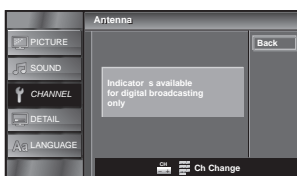

5 Press **[SETUP]** to exit.

SETUP



## Language Selection

You can choose English, Spanish, or French as your on-screen language.

1 Press **[SETUP]** to display the main menu.

SETUP



2 Use **[Cursor ▲/▼]** to select "LANGUAGE", then press **[ENTER]**.



or



ENTER



3 Use **[Cursor ▲/▼]** to select "English", "Español" or "Français", then press **[ENTER]**.



or



ENTER

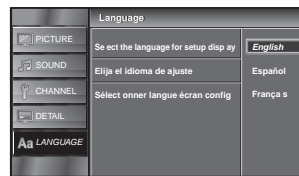

4 Press **[SETUP]** to exit.

SETUP



### Note:

- If you need the English menus instead of the Spanish or French menus, press **[SETUP]**. Use **[Cursor ▲/▼]** to select "IDIOMA" or "LANGUE", then press **[ENTER]**. Use **[Cursor ▲/▼]** to select "English", then press **[ENTER]**. Press **[SETUP]** to exit the main menu.

## ✓ Picture Adjustment

You can adjust brightness, contrast, color, tint, sharpness and color temperature.

**Before you begin:** You must set "Home" in "Location" (Refer to page 31). Otherwise, the settings you adjusted will not be memorized after you turn off the unit.

- 1 Press **[SETUP]** to display the main menu.



- 2 Use **[Cursor ▲/▼]** to select "PICTURE", then press **[ENTER]**.

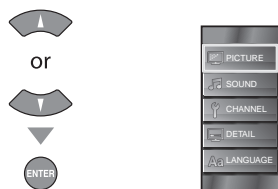

- 3 Use **[Cursor ▲/▼]** to select the item you want to adjust, then press **[ENTER]**.

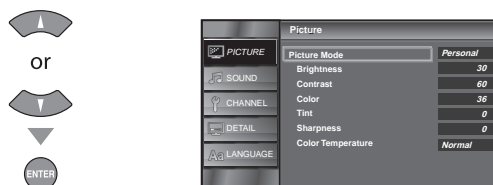

- 4 Adjust the picture quality.

### Picture Mode

Use **[Cursor ▲/▼]** to select the desired setting, then press **[ENTER]**. ("Personal", "Standard", "Sports", "Movie" and "Game")



### Brightness, Contrast, Color, Tint, Sharpness, Color Temperature

Use **[Cursor ▲/▼]** to select the desired setting, then use **[Cursor ◀/▶]** to adjust.

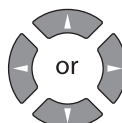

	Cursor ◀	Cursor ▶
<b>Brightness</b> 	to decrease brightness	to increase brightness
<b>Contrast</b> 	to decrease contrast	to increase contrast
<b>Color</b> 	to decrease color intensity	to increase color intensity
<b>Tint</b> 	to add red	to add green
<b>Sharpness</b> 	to soften	to sharpen
<b>Color Temperature</b> 	to add warm colors	to add cool colors

- 5 Press **[SETUP]** to exit.



#### Note:

- To cancel picture adjustment, press **[SETUP]**.
- Only the "Personal" setting can be adjusted.

## ✓ Sound Adjustment

You can adjust the sound mode, equalizer and some other sound functions.

**Before you begin:** You must set "Home" in "Location" (Refer to page 31). Otherwise, the settings you adjusted will not be memorized after you turn off the unit.

1 Press **[SETUP]** to display the main menu.



2 Use **[Cursor ▲/▼]** to select "SOUND", then press **[ENTER]**.

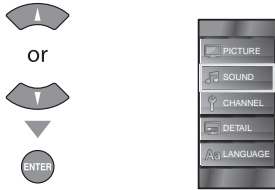

3 Use **[Cursor ▲/▼]** to select the sound type you want to adjust, then press **[ENTER]**.

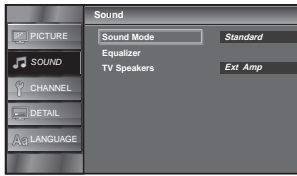

4 Adjust the following items.

### Sound Mode

Use **[Cursor ▲/▼]** to select the desired setting, then press **[ENTER]**.

("Personal", "Standard", "Movie", "Music" and "News")

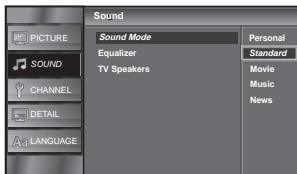

### Equalizer

Adjust tonal quality for each frequencies.

Use **[Cursor ◀/▶]** to select the specific frequency and use **[Cursor ▲/▼]** to adjust the level, then press **[ENTER]**.

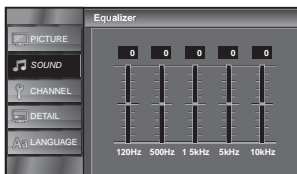
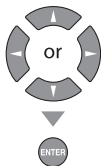

### TV Speakers

Select the audio output from the unit's speakers, or not. If your amplifier compatible with the CEC function is connected to this unit using an HDMI cable, some part of the sound operations such as volume up can access synchronized by using this unit's remote control.

Use **[Cursor ▲/▼]** to select the desired option, then press **[ENTER]**.

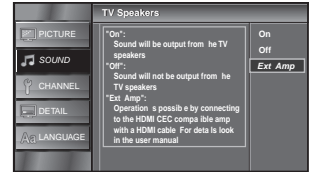

<b>On</b>	The sound will be output from the unit's speakers.
<b>Off</b>	The sound will not be output from the unit's speakers.
<b>Ext. Amp</b>	This function allows you to control audio output from CEC-compatible devices with the unit's remote control.

5 Press **[SETUP]** to exit.



### Note:

- To cancel sound adjustment, press **[SETUP]**.
- We do not guarantee 100% interoperability with other brands of CEC compliant devices.



## ✓ Closed Caption

You can view closed captioning (CC) for TV programs, movies and news. Closed caption refers to text of dialogue or descriptions displayed on-screen.

1 Press **[SETUP]** to display the main menu.



2 Use **[Cursor ▲/▼]** to select "DETAIL", then press **[ENTER]**.

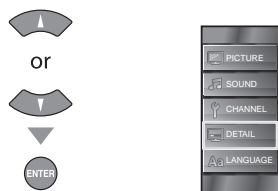

3 Use **[Cursor ▲/▼]** to select "Closed Caption", then press **[ENTER]**.

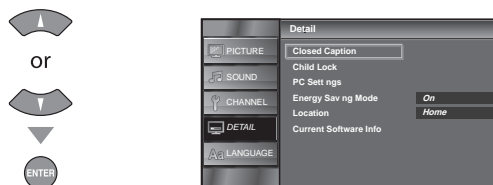

See the following description for setting each item.

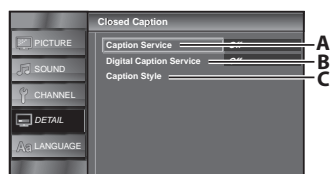

A... "A. Caption Service" ⇒ page 23

B... "B. Digital Caption Service" ⇒ page 24

C... "C. Caption Style" ⇒ page 24

## A. Caption Service

4 Use **[Cursor ▲/▼]** to select "Caption Service", then press **[ENTER]**.

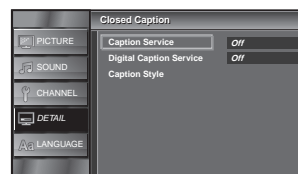
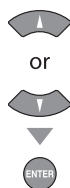

5 Use **[Cursor ▲/▼]** to select the desired closed caption, then press **[ENTER]**.

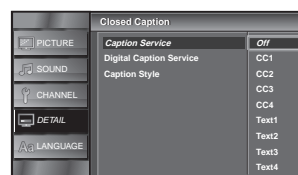
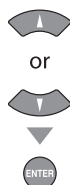

### Caption mode

#### CC1 and Text1;

are the primary caption and text services.

The captioning or text is displayed in the same language as the program's dialogue (up to 4 lines of script on the TV screen, where it does not obstruct relevant parts of the picture).

#### CC3 and Text3;

serve as the preferred data channels.

The captioning or text is often a secondary language.

#### CC2, CC4, Text2 and Text4;

are rarely available and broadcasters use them only in special conditions, such as when "CC1" and "CC3" or "Text1" and "Text3" are not available.

- There are 3 display modes according to programs:

#### Paint-on mode:

Displays input characters on the TV screen immediately.

#### Pop-on mode:

Once characters are stored in memory, they are displayed all at once.

#### Roll-up mode:

Displays the characters continuously by scrolling (max. 4 lines).

6 Press **[SETUP]** to exit.



## B. Digital Caption Service

DTV

In addition to the basic closed caption described on page 23, DTV has its own closed caption called digital caption service. Use this menu to change the settings for digital caption service.

- 4 Use [Cursor ▲/▼] to select "Digital Caption Service", then press [ENTER].



- 5 Use [Cursor ▲/▼] to select the desired digital caption service, then press [ENTER].

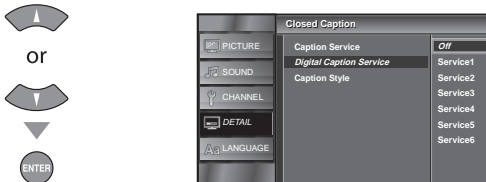

<b>Off</b>	Select if you do not want digital caption service. This is the default.
<b>Service 1~6</b>	Select one of these before changing any other item in "Closed Caption" menu. Choose "Service 1" under normal circumstances.

- 6 Press [SETUP] to exit.



**Note:**

- "Digital Caption Service" that you can switch differs depending on the broadcast description.

## C. Caption Style

DTV

You can change the caption style such as font, color or size, etc.

- 4 Use [Cursor ▲/▼] to select "Caption Style", then press [ENTER].

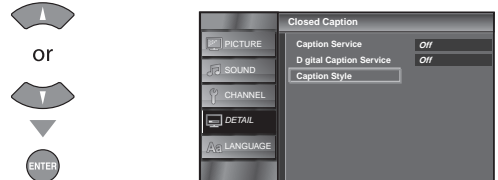

- 5 Use [Cursor ▲/▼] to select "User Setting", then press [ENTER].



- 6 Use [Cursor ▲/▼] to select "On", then press [ENTER].



- 7 Use [Cursor ▲/▼] to select an item, then press [ENTER]. Then use [Cursor ▲/▼] to select the desired setting and press [ENTER].

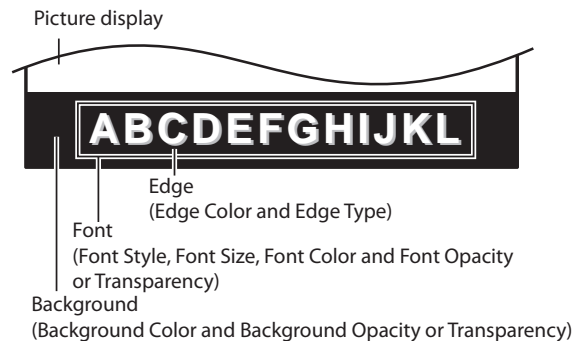

- The setting description for each item is shown on the next page.
- Review your setting choice made on the next page by looking in the upper right corner of the displayed setting box (not all selections show the differences selected).

## Font Style

Closed Captioning font style can be changed as below.

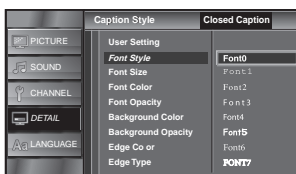

## Font Size

Font size of the displayed caption can be switched as below.

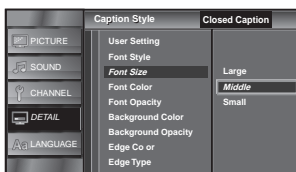

## Font Color

Font color of the displayed caption can be switched as below.

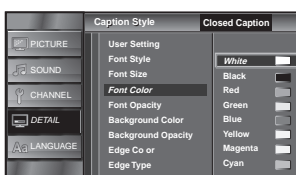

## Font Opacity

Font opacity of the displayed caption can be switched as below.

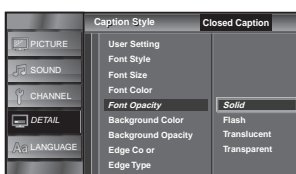

## Background Color

Background color of the displayed caption can be switched as below.

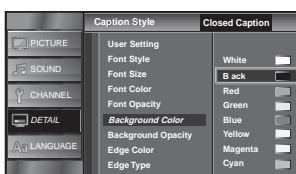

## Background Opacity

Background opacity of the displayed caption can be switched as below.

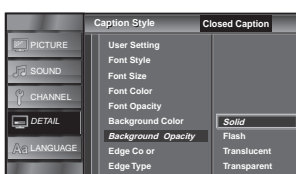

## Edge Color

Edge color of the displayed caption can be switched as below.

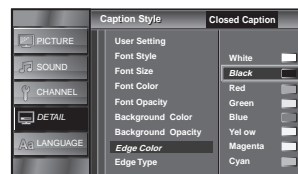

## Edge Type

Edge type of the displayed caption can be switched as below.

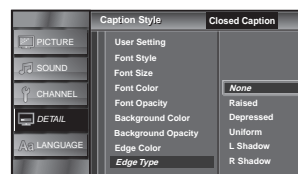

8 Press **[SETUP]** to exit.

SETUP



### Note:

- To show the closed caption on your TV screen, broadcast signal must contain the closed caption data.
- Not all TV programs and commercials have the closed caption or all types of the closed caption.
- Captions and texts may not match the TV voice exactly.
- Changing channels may delay the closed caption for a few seconds.
- Adjusting or muting the volume may delay the closed caption for a few seconds.
- Abbreviations, symbols and other grammatical shortcuts may be used in order to keep pace with the on-screen action. This is not a malfunction.
- The caption or text characters will not be displayed while the main menu or functions display is shown.
- If a black box appears on the TV screen, this means that the closed caption is set to the text mode. To clear the box, select "CC1", "CC2", "CC3", "CC4" or "Off".
- If the unit receives poor quality television signals, the captions may contain errors, or there might be no captions at all. Some possible causes of poor quality signals are:
  - Automobile ignition noise
  - Electric motor noise
  - Weak signal reception
  - Multiplex signal reception (ghosts or screen flutter)
- The unit retains the closed caption setting if the power fails.
- Closed caption will not be displayed when you are using an HDMI connection.
- When the unit receives special effects playback signal (i.e., Search, Slow and Still) from a VCR's video output channel (CH3 or CH4), the unit may not display the correct caption or text.

## ✓ Child Lock

Child lock reads the ratings for programs, then denies access to the programs which exceed the rating level you set. With this function, you can block certain programs inappropriate for children and any channels or external input modes can be invisible.

1 Press **[SETUP]** to display the main menu.



2 Use **[Cursor ▲/▼]** to select "DETAIL", then press **[ENTER]**.



3 Use **[Cursor ▲/▼]** to select "Child Lock", then press **[ENTER]**.

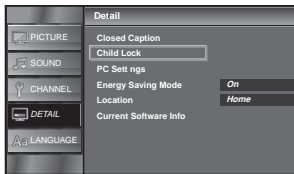
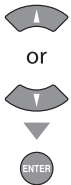

4 Use **[the Number buttons]** to enter the 4-digit numbers for your PIN Code.

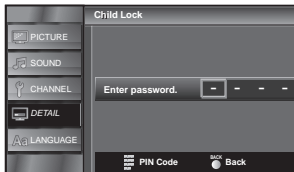
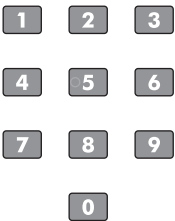

- When you have not set up your PIN Code, enter 0000.
- When the PIN Code is correct, "Child Lock" menu is displayed.

See the following description for setting each item.



A... "A. Channel Lock" ⇨ page 27

B... "B. MPA A Rating" ⇨ page 27

C... "C. TV Rating" ⇨ page 28

D... "D. New Password" ⇨ page 29

### Note:

- When you select a rating and set it to "Block", the higher ratings will be blocked automatically. The lower ratings will be available for viewing.
- When you set the highest rating to "View", all ratings turn to "View" automatically.
- To block any inappropriate programs, set your limits in "MPAA Rating", "TV Rating" and "Downloadable Rating".
- The child lock setting will be retained after a power failure (except the access code reverts to 0000).
- If the rating is blocked, will appear.
- "Downloadable Rating" will be available when the unit receives a digital broadcast using the new rating system.
- If the broadcasting signal does not have the Downloadable Rating information, "Downloadable Rating is currently not available." will appear. This message will also appear when you try to access "Downloadable Rating" after you have cleared the Downloadable Rating information, and the new information has not been downloaded since.
- The Canadian rating systems on this unit based on CEA-766-A and the Canadian Radio-Television and Telecommunications Commission (CRTC) policy.

## A. Channel Lock

Particular channels or external input modes can be invisible in this function.

- 5 Use [Cursor ▲/▼] to select "Channel Lock", then press [ENTER].

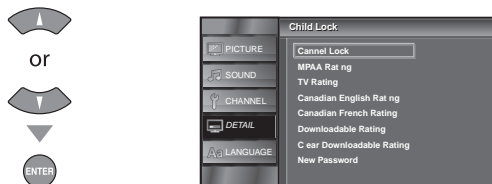

- 6 Use [Cursor ▲/▼] to select the desired rating, then press [ENTER] repeatedly to switch between "View" and "Block".



- 7 Press [SETUP] to exit.



## B. MPAA Rating

MPAA Rating is the rating system created by MPAA (Motion Picture Association of America).

- 5 Use [Cursor ▲/▼] to select "MPAA Rating", then press [ENTER].



- 6 Use [Cursor ▲/▼] to select the desired rating, then press [ENTER] repeatedly to switch between "View" and "Block".



Rating	Category
X	Mature audience only
NC-17	No one under 17 admitted
R	Restricted; under 17 requires accompanying parent or adult guardian
PG-13	Unsuitable for children under 13
PG	Parental guidance suggested
G	General audience
NR	No rating

- 7 Press [SETUP] to exit.



## C. TV Rating

5 Use [Cursor ▲/▼] to select "TV Rating", then press [ENTER].

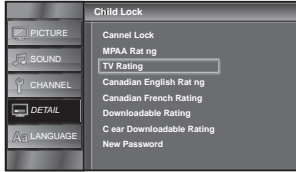
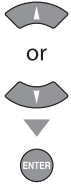

6 Use [Cursor ▲/▼/◀/▶] to select the desired rating, then press [ENTER] repeatedly to switch between "View" and "Block".

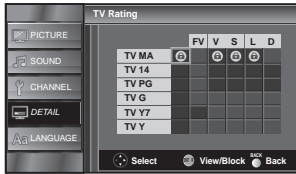
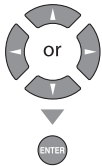

7 Press [SETUP] to exit.



### To set the sub ratings

As for TV-MA, TV-14, TV-PG, or TV-Y7, you can further set the sub ratings to block specific elements of programming. To set the sub ratings, follow the step below.

Use [Cursor ▲/▼/◀/▶] to select the desired rating, then press [ENTER] repeatedly to switch between "View" and "Block".

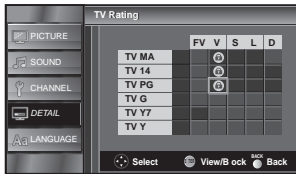
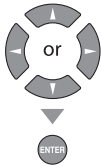

Rating	Category	
TV-MA	Mature audience only	higher ↑ ↓ lower
TV-14	Unsuitable for children under 14	
TV-PG	Parental guidance suggested	
TV-G	General audience	
TV-Y7	Appropriate for all children 7 and older	
TV-Y	Appropriate for all children	lower

Sub Rating	Category	Rating
FV	Fantasy Violence	TV-Y7
V	Violence	TV-PG
S	Sexual Situation	TV-14
L	Coarse Language	TV-MA
D	Suggestive Dialogue	TV-PG, TV-14

### Note:

- Blocked sub rating will appear beside the main rating category in "TV Rating" menu.
- You cannot block a sub rating (D, L, S or V) if the main rating is set to "View".
- Changing the category to "Block" or "View" automatically changes all its sub ratings to the same ("Block" or "View").

## D. New Password

Although the default code "0000" is supplied with the unit, you can set your own PIN Code.

- 5 Use [Cursor ▲/▼] to select "New Password", then press [ENTER].

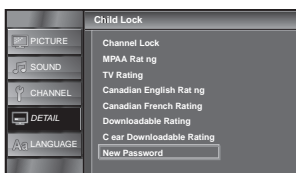
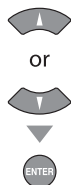

- 6 Press [the Number buttons] to enter the new 4-digit PIN Code.

- Enter PIN Code again in "Confirm password." entry field.

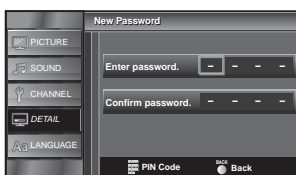
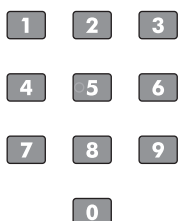

- 7 Press [SETUP] to exit.



### Note:

- Make sure new PIN Code and confirm PIN Code must be exactly the same. If they are different, the space is cleared for reentering.
- Your PIN Code will be erased and return to the default (0000) when a power failure occurs. If you forget the PIN Code, unplug the AC power cord for 10 seconds to restore the PIN Code to 0000.



## ✓ PC Settings

This function lets you adjust the PC screen position, clock and phase during PC input.

1 Press **[SETUP]** to display the main menu.



2 Use **[Cursor ▲/▼]** to select "DETAIL", then press **[ENTER]**.

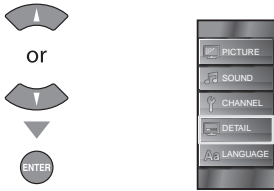

3 Use **[Cursor ▲/▼]** to select "PC Settings", then press **[ENTER]**.

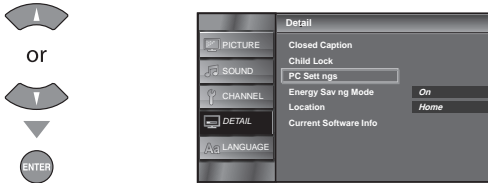

4 Use **[Cursor ▲/▼]** to select the setting you want to adjust, then press **[ENTER]**.

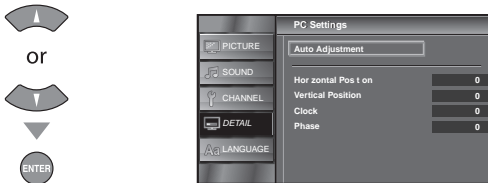

5 Adjust the setting.

### Auto Adjustment

Use **[Cursor ▲/▼]** to select "Adjust", then press **[ENTER]**.



- The horizontal/vertical position, clock and phase of the PC screen are automatically adjusted.

### Horizontal Position, Vertical Position

Use **[Cursor ◀/▶]** to adjust.

	Cursor ◀	Cursor ▶
<b>Horizontal Position</b> 	to move PC screen left	to move PC screen right
<b>Vertical Position</b> 	to move PC screen down	to move PC screen up

### Clock, Phase

Use **[Cursor ◀/▶]** to adjust "Clock" setting to stabilize the PC screen and "Phase" setting to improve the clarity of the PC screen.

	Cursor ◀	Cursor ▶
<b>Clock</b> 	to decrease setting value	to increase setting value
<b>Phase</b> 		

6 Press **[SETUP]** to exit.



### Note:

- You may not obtain an appropriate screen with "Auto Adjustment" for some signals. In this case, adjust the settings manually.
- Adjust "Phase" setting after "Clock" setting has been properly adjusted.

## ✓ Energy Saving Mode

You can set whether the power consumption is saved or not.

- 1 Press **[SETUP]** to display the main menu.

SETUP



- 2 Use **[Cursor ▲/▼]** to select "DETAIL", then press **[ENTER]**.



or



ENTER



## ✓ Location

When you select "Retail", the power consumption may possibly exceed the limited requirement of the ENERGY STAR® qualification.

- 1 Press **[SETUP]** to display the main menu.

SETUP



- 2 Use **[Cursor ▲/▼]** to select "DETAIL", then press **[ENTER]**.



or



ENTER

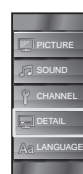

- 3 Use **[Cursor ▲/▼]** to select "Energy Saving Mode", then press **[ENTER]**.



or



ENTER

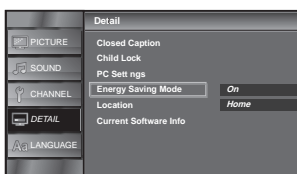

- 3 Use **[Cursor ▲/▼]** to select "Location", then press **[ENTER]**.



or



ENTER

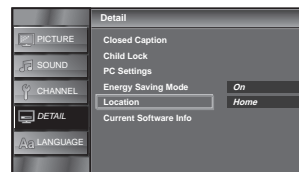

- 4 Use **[Cursor ▲/▼]** to select the desired mode, then press **[ENTER]**.



or



ENTER

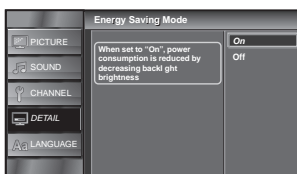

- 4 Use **[Cursor ▲/▼]** to select the desired location, then press **[ENTER]**.



or



ENTER

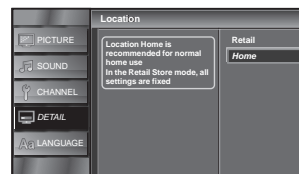

<b>On</b>	Select if you want to reduce the power consumption.
<b>Off</b>	The power consumption may possibly exceed the limited requirement of the ENERGY STAR® qualification.

- 5 Press **[SETUP]** to exit.

SETUP



- 5 Press **[SETUP]** to exit.

SETUP



## ✓ **Current Software Info**

This function shows what version of the software currently used.

**1** Press **[SETUP]** to display the main menu.

SETUP



**2** Use **[Cursor ▲/▼]** to select "DETAIL", then press **[ENTER]**.



or



ENTER



**3** Use **[Cursor ▲/▼]** to select "Current Software Info", then press **[ENTER]**.



or



ENTER

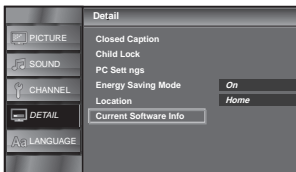

**4** Confirm the version of the software currently used.

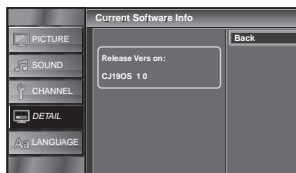

**5** Press **[SETUP]** to exit.

SETUP



 **FAQ**

Question	Answer
My remote control does not work. What should I do?	<ul style="list-style-type: none"> <li>• Check the antenna or cable connection to the main unit.</li> <li>• Check the batteries of the remote control.</li> <li>• Check if there is an obstacle between the infrared sensor window and the remote control.</li> <li>• Test the signal output. If OK, then possible infrared sensor trouble. (Refer to "IR Signal Check" on page 36.)</li> <li>• Aim the remote control directly at the infrared sensor window on the front of the unit.</li> <li>• Reduce the distance to the unit.</li> <li>• Re-insert the batteries with their polarities (+/- signs) as indicated.</li> <li>• When there is an infrared-equipped device such as PC near this unit, it may interrupt the remote control signal of this unit.</li> <li>• Move the infrared-equipped device away from this unit, change the angle of the infrared sensor or turn off the infrared communication function.</li> </ul>
How come the Initial setup appears every time I turn on this unit?	<ul style="list-style-type: none"> <li>• Connect the RF coaxial cable to the unit directly and run the initial setup.</li> <li>• Make sure to complete the channel scan before turning off the unit.</li> </ul>
Why I cannot watch some TV programs.	<ul style="list-style-type: none"> <li>• Make sure autoscanner has been completed. (Refer to "Autoscan" on page 18.)</li> <li>• Autoscan must be completed when you set up the unit for the first time or move it to a location where previously unavailable channels are broadcast.</li> <li>• The selected channel may not be broadcasting.</li> <li>• When autoscan is interrupted and not completed, some channels will not be received. Make sure to complete. (Refer to "Autoscan" on page 18.)</li> <li>• The selected channel cannot be viewed by the "Child Lock" setting. (Refer to "Child Lock" on page 26.)</li> <li>• The unit requires some kind of antenna input. An indoor antenna (VHF /UHF), an external antenna (VHF /UHF) or an RF coaxial cable from your wall cable/satellite box needs to be plugged into the unit.</li> </ul>
How come there is no image from the connected external devices?	<ul style="list-style-type: none"> <li>• Check if the right input mode is selected by pressing <b>[INPUT SELECT]</b> or using <b>[CHANNEL - / +]</b>. (Refer to "Switching Each Input Mode" on page 15.)</li> <li>• Check the antenna or cable connection to the unit.</li> <li>• When using the Composite Video Connection check that the Green (Y), Blue (Pb/Cb) and Red (Pr/Cr) connectors are connected to their corresponding colored jacks on the unit.</li> </ul>
Whenever I entered channel number, it changes automatically.	<ul style="list-style-type: none"> <li>• Many digital channels have alternate channel numbers. The unit changes the numbers automatically to the ones signifying the broadcasting stations. These are the numbers used for analog broadcasts.</li> </ul>
Why are captions not displayed entirely? Or, captions are delayed behind the dialogue.	<ul style="list-style-type: none"> <li>• Captions that are delayed a few seconds behind the actual dialogue are common for live broadcasts. Most captioning production companies can display a dialogue to maximum of 220 words per minute. If a dialogue exceeds that rate, selective editing is used to insure that the captions remain up-to date with the current TV screen dialogue.</li> </ul>
How can I set the clock ?	<ul style="list-style-type: none"> <li>• There is no clock function on this unit.</li> </ul>

## ✓ Troubleshooting Guide

If the unit does not perform properly when operated as instructed in this manual, **check the following chart and all connections once before calling for service.**

Symptom	Remedy
No power	<ul style="list-style-type: none"> <li>• Make sure the AC power cord is plugged in.</li> <li>• Make sure that the AC outlet supplies the proper voltage, plug another electrical appliance into the AC outlet.</li> <li>• If a power failure occurs, unplug the AC power cord for 1 minute to allow the unit to reset itself.</li> </ul>
Control button does not work.	<ul style="list-style-type: none"> <li>• Press only one button at a time. Do NOT press more than one buttons at the same time.</li> </ul>
Power is ON but no screen image.	<ul style="list-style-type: none"> <li>• Check whether the connection of the antenna, cable receiver or satellite box is connected correctly.</li> <li>• Check whether all the cables to the unit are connected to the correct output jack of your device like BD/DVD recorder.</li> <li>• Make sure that the selected input mode is connected to the working input jack.</li> <li>• Check if your computer is NOT in sleep mode when the input mode of this unit is in PC mode. Tap any key on the keyboard to wake up your computer.</li> </ul>
No picture or sound	<ul style="list-style-type: none"> <li>• Check if the power is on.</li> <li>• Check if the right input mode is selected.</li> <li>• Check whether all the cables to the unit are connected to the correct output jack of your device like BD/DVD recorder.</li> <li>• View other TV channels. The problem might be limited to the broadcasting station.</li> <li>• Turn off the unit and wait for about 1 minute, then turn on the unit again.</li> <li>• Check whether the connection of the antenna, cable receiver or satellite box is connected correctly.</li> <li>• Make sure that the selected input mode is connected to the working input jack.</li> <li>• Check if your computer is NOT in sleep mode when the input mode of this unit is in PC mode. Tap any key on the keyboard to wake up your computer.</li> <li>• Make sure that the sound is not muted. Press <b>[MUTE]</b> so that the volume bar and current volume level will appear on the TV screen.</li> <li>• Make sure that the volume is NOT set to "0" or "Mute". If so, use <b>[VOLUME -/+]</b> to adjust the desired volume.</li> </ul>
No color	<ul style="list-style-type: none"> <li>• View other TV channels. The problem might be limited to the broadcasting station.</li> <li>• Adjust "Color" in the main menu.</li> </ul>
Adjusted "PICTURE" or "SOUND" is not effective every time turn on the unit.	<ul style="list-style-type: none"> <li>• You must set "Home" in "Location" (Refer to page 31). Otherwise, the settings you adjusted will not be memorized after you turn off the unit.</li> </ul>
Sound OK, picture poor	<ul style="list-style-type: none"> <li>• Electrical interference from nearby appliances may affect picture quality.</li> <li>• Adjust "Contrast" and "Brightness" in the main menu.</li> <li>• View other TV channels. The problem might be limited to the broadcasting station.</li> <li>• For the best picture quality, watch "high definition" wide screen programs. If the HD content is not available, watch "standard definition" programs instead.</li> </ul>
Picture OK, sound poor	<ul style="list-style-type: none"> <li>• View other TV channels. The problem might be limited to the broadcasting station.</li> <li>• Check if the audio cable is connected in correctly.</li> </ul>
You see a distorted picture or hear an unusual sound.	<ul style="list-style-type: none"> <li>• You may be getting interference from electrical appliances, automobiles, motorcycles or fluorescent lights.</li> <li>• Try moving the unit to another location to see if this is the cause of the problem.</li> </ul>
Ghosts, lines or streaks in picture	<ul style="list-style-type: none"> <li>• Electrical interference from nearby appliances may affect picture quality.</li> <li>• View other TV channels. The problem might be limited to the broadcasting station.</li> </ul>
You see "noise" or "trash" on the screen.	<ul style="list-style-type: none"> <li>• When the capabilities of the unit exceed the capabilities of the digital broadcasting, the signal will be increased to match the capabilities of the display of the unit. This may cause noise or trash.</li> </ul>
Different color marks on the TV screen	<ul style="list-style-type: none"> <li>• View other TV channels. The problem might be limited to the broadcasting station.</li> </ul>

Symptom	Remedy
You switch to a different input and the volume.	<ul style="list-style-type: none"> <li>This unit will memorize the volume level from the last time you adjusted it.</li> <li>If the volume of the sound from another device is higher or lower, then the loudness will change.</li> </ul>
You switch to a different input and the screen size changes.	<ul style="list-style-type: none"> <li>This unit will memorize the viewing mode from the last time you used the particular input modes.</li> </ul>
The display image does not cover the entire screen.	<ul style="list-style-type: none"> <li>If you are using the unit as a PC monitor, make sure that "Horizontal Position" and "Vertical Position" in "PC Settings" are set correctly.</li> <li>If you are watching TV or using the video, S-video, component video or HDMI with 480i input, press <b>[SCREEN MODE]</b> repeatedly to switch various screen modes.</li> </ul>
Captions are displayed as a white box. No caption is displayed in the Closed Caption-supported program.	<ul style="list-style-type: none"> <li>Interference from buildings or weather conditions may cause captioning to be incomplete.</li> <li>Broadcasting station may shorten the program to insert advertisement. The closed caption decoder cannot read the information of the shortened program.</li> </ul>
No caption is displayed when playing back a disc or a cassette tape containing captions.	<ul style="list-style-type: none"> <li>The disc or cassette tape may be illegally copied, or the caption signal might not have been read during copying.</li> </ul>
Black box is displayed on the TV screen.	<ul style="list-style-type: none"> <li>The text mode is selected for caption. Select "CC1", "CC2", "CC3", "CC4" or "Off".</li> </ul>

**Note:**

- The LCD panel is manufactured to provide many years of useful life. Occasionally a few non active pixels may appear as a fixed point of blue, green or red. This is not to be considered a defect in the LCD screen.
- Some functions are not available in specific modes, but this is not a malfunction. Read the description in this manual for more details on correct operations.

## ✓ Glossary

### ATSC

Acronym that stands for Advanced Television Systems Committee and the name of the digital broadcasting standards.

### Aspect Ratio

The width of a TV screen relative to its height. Conventional TVs are 4:3 (in other words, the TV screen is almost square); widescreen models are 16:9 (the TV screen is almost twice as wide as its height).

### CEC (Consumer Electronics Control)

This allows you to operate the linked functions between our brand devices with CEC feature and this unit. We do not guarantee 100% interoperability with other brands of CEC compliant devices.

### Component Video

This is a video signal format that conveys each of 3 principal colors of light (red, blue and green) through different signal lines. This allows the viewers to experience picture colors as original as it is. There are several signal formats, including Y / Pb / Pr and Y / Cb / Cr.

### Dolby Digital

The system developed by Dolby Laboratories to compress digital sound. It offers stereo sound (2ch) or multi-channel audio.

### HDMI

#### (High-Definition Multimedia Interface)

Interface that supports all uncompressed, digital audio/video formats including set-top box, BD/DVD recorder or digital television, over a single cable.

### HDTV (High Definition TV)

Ultimate digital format that produces high resolution and high picture quality.

### NTSC

Acronym that stands for National Television Systems Committee and the name of the current analog broadcasting standards. Off the air NTSC signals will no longer be sent by broadcasting stations after Feb 17, 2009.

### Password / PIN Code

A stored 4-digit number that allows access to parental control features.

### SAP (Secondary Audio Program)

Second-audio channel delivered separately from main-audio channel. This audio channel is used as an alternate in bilingual broadcasting.

### SDTV (Standard Definition TV)

Standard digital format that is similar to the NTSC picture quality.

### S-video

Offers higher quality images by delivering each signal, color (c) and luminance (y) independently of each other through a separate cable.

## ✓ Maintenance

### Cabinet Cleaning

- Wipe the front panel and other exterior surfaces of the unit with a soft cloth immersed in lukewarm water and wrung dry.
- Never use a solvent or alcohol. Do not spray insecticide liquid near the unit. Such chemicals may cause damage and discoloration to the exposed surfaces.

### Panel Cleaning

Wipe the panel of the unit with a soft cloth. Before cleaning the panel, disconnect the AC power cord.

### Servicing

Should your unit become inoperative, do not try to correct the problem yourself. There are no user serviceable parts inside. Turn off the unit, unplug the AC power cord and call our toll free customer support line found on the cover of this manual to locate an authorized service center.

### IR Signal Check

If the remote control is not working properly, you can use a digital camera (including a cellular phone with built-in camera) to see if it is sending out an infrared signal.



- With a digital camera (including built-in cell phone cameras): Point the Digital Camera towards the remote control infrared diode at the front of the remote control. Press any button on the remote control and look through the camera display. If the infrared pulsating light appears through the camera, the remote control is sending out an IR signal.

## ✓ Cable Channel Designations

If you subscribe to cable TV, the channels are displayed as 1-135. Cable companies often designate channels with letters or letter-number combinations. Please check with your local cable company. The following is a chart of common cable channel designations.

CATV channel	5A	2	3	4	5	6	7	8	9	10	11	12	13	A	B	C	D	E	F	G	H
TV Display	1	2	3	4	5	6	7	8	9	10	11	12	13	14	15	16	17	18	19	20	21
CATV channel	I	J	K	L	M	N	O	P	Q	R	S	T	U	V	W	W+1	W+2	W+3	W+4	W+5	W+6
TV Display	22	23	24	25	26	27	28	29	30	31	32	33	34	35	36	37	38	39	40	41	42
CATV channel	W+7	W+8	W+9	W+10	W+11	W+12	W+13	W+14	W+15	W+16	W+17	W+18	W+19	W+20	W+21	W+22	W+23	W+24	W+25	W+26	W+27
TV Display	43	44	45	46	47	48	49	50	51	52	53	54	55	56	57	58	59	60	61	62	63
CATV channel	W+28	W+29	W+30	W+31	W+32	W+33	W+34	W+35	W+36	W+37	W+38	W+39	W+40	W+41	W+42	W+43	W+44	W+45	W+46	W+47	W+48
TV Display	64	65	66	67	68	69	70	71	72	73	74	75	76	77	78	79	80	81	82	83	84
CATV channel	W+49	W+50	W+51	W+52	W+53	W+54	W+55	W+56	W+57	W+58	A-5	A-4	A-3	A-2	A-1	W+59	W+60	W+61	W+62	W+63	W+64
TV Display	85	86	87	88	89	90	91	92	93	94	95	96	97	98	99	100	101	102	103	104	105
CATV channel	W+65	W+66	W+67	W+68	W+69	W+70	W+71	W+72	W+73	W+74	W+75	W+76	W+77	W+78	W+79	W+80	W+81	W+82	W+83	W+84	W+85
TV Display	106	107	108	109	110	111	112	113	114	115	116	117	118	119	120	121	122	123	124	125	126
CATV channel	W+86	W+87	W+88	W+89	W+90	W+91	W+92	W+93	W+94												
TV Display	127	128	129	130	131	132	133	134	135												

## ✓ General Specifications

<b>TV format:</b>	ATSC / NTSC-M TV standard
<b>Closed caption system:</b>	§15.122 / FCC (digital CC) §15.119 / FCC (analog CC)
<b>Channel coverage (ATSC/NTSC):</b>	
<b>Terrestrial</b>	<b>VHF:</b> 2~13 <b>UHF:</b> 14~69
<b>CATV</b>	2~13, A~W, W+1~W+94 (analog W+1~W+84), A-5~A-1, 5A
<b>Tuning system:</b>	Channel frequency synthesized tuning system
<b>Channel access:</b>	Direct access keyboard, Programmable scan, and up / down

## ✓ Electrical Specification

<b>Sound Output:</b>	3W, 8Ω x 2
----------------------	------------

## ✓ Other Specifications

<b>Terminals:</b>	
<b>Antenna input:</b>	VHF / UHF / CATV    75Ω unbalanced (F-type)
<b>Audio input:</b>	RCA jack (L/R) x 6    500mV rms
<b>Video input:</b>	RCA jack x 1    1V p-p (75Ω)
<b>S-video input:</b>	Mini DIN 4-pin jack x 1    Y: 1V p-p (75Ω) C: 286mV p-p (75Ω)
<b>Component video input:</b>	RCA jack x 3    Y: 1V p-p (75Ω) Pb/Cb: 700mV p-p (75Ω) Pr/Cr: 700mV p-p (75Ω)
<b>HDMI input:</b>	HDMI 19pin x 2
<b>PC input:</b>	D-Sub 15pin x 1 (RGB) Mini jack ø3.5mm x 1 (audio)
<b>Coaxial digital audio output:</b>	RCA jack x 1    500mV p-p (75Ω)
<b>Headphone:</b>	1/8 inches x 1 (3.5mm)

**Remote control:** Digital encoded infrared light system

**Operating temperature:**  
41°F (5°C) to 104°F (40°C)

**Power requirements:**  
120V~ AC +/- 10%, 60Hz +/- 0.5%

**Power consumption (maximum):**

55W

**LCD:** 19 inches class (18.5 inches measured diagonally)

<b>Dimensions:</b>	<without stand>	<with stand>
<b>W:</b>	18.8 inches (477.5mm)	18.8 inches (477.5mm)
<b>H:</b>	13.1 inches (330.4mm)	14.5 inches (365.8mm)
<b>D:</b>	3.7 inches (91.7mm)	8.3 inches (210.0mm)

**Weight:** 8.0 lbs. (3.6kg)    8.6 lbs. (3.9kg)

- Designs and specifications are subject to change without notice and without our legal obligation.
- If there is a discrepancy between languages, the default language will be English.



# ***TO OUR VALUED CUSTOMER*** ———

THANK YOU FOR PURCHASING THIS JVC PRODUCT.  
WE WANT TO HELP YOU ACHIEVE A PERFECT EXPERIENCE.

**NEED HELP ON HOW TO HOOK UP?  
NEED ASSISTANCE ON HOW TO OPERATE?  
NEED TO LOCATE A JVC SERVICE CENTER?  
LIKE TO PURCHASE ACCESSORIES?**

**JVC<sup>®</sup> IS HERE TO HELP!**  
**TOLL FREE: 1(800)252-5722**  
**<http://www.jvc.com>**

Remember to retain your Bill of Sale for Warranty Service.

————— **Do not attempt to service the product yourself** —————

**Caution**

To prevent electrical shock, do not open the cabinet.  
There are no user serviceable parts inside.  
Please refer to qualified service personnel for repairs.

---



# LIMITED WARRANTY

1-1 **USA ONLY**

**ONLY FOR PRODUCT PURCHASED IN U.S.A.**

JVC Americas Corp. (JVC) warrants this product and all parts thereof, except as set forth below **ONLY TO THE ORIGINAL RETAIL PURCHASER** to be **FREE FROM DEFECTIVE MATERIALS AND WORKMANSHIP** from the date of original purchase for the period shown below. ("The Warranty Period")

PARTS	<b>1 YR</b>	LABOR	<b>1 YR</b>
-------	-------------	-------	-------------

**THIS LIMITED WARRANTY IS VALID ONLY IN THE FIFTY (50) UNITED STATES, THE DISTRICT OF COLUMBIA AND IN THE COMMONWEALTH OF PUERTO RICO.**

**WHAT WE WILL DO:**

If this product is found to be defective within the warranty period, JVC will repair or replace defective parts with new or rebuilt equivalents at no charge to the original owner. Such repair and replacement services shall be rendered by JVC during normal business hours at JVC authorized service centers. Parts used for replacement are warranted only for the remainder of the Warranty Period. All products may be brought to a JVC authorized service center on a carry-in basis. Color televisions with a screen size of 37" class or greater qualify for in-home service. In such cases, a technician will come to your home and either repair the TV there or remove and return it if it cannot be repaired in your home.

**WHAT YOU MUST DO FOR WARRANTY SERVICE:**

***Please do not return your product to the retailer***

**Instead, return your product to the JVC authorized service center nearest you. If shipping the product to the service center, please be sure to package it carefully, preferably in the original packaging, and include a brief description of the problem(s). Please call 1-800-252-5722 to locate the nearest JVC authorized service center. Service locations can also be obtained from our website <http://www.jvc.com>. If your product qualifies for in-home service, the service representative will require clear access to the product.**

If you have any questions concerning your JVC Product, please contact our Customer Care Center at 800-252-5722

**WHAT IS NOT COVERED:**

This limited warranty provided by JVC does not cover:

1. Products which have been subject to abuse, accident, alteration, modification, tampering, negligence, misuse, faulty installation, lack of reasonable care, or if repaired or serviced by anyone other than a service facility authorized by JVC to render such service, or if affixed to any attachment not provided with the products, or if the model or serial number has been altered, tampered with, defaced or removed;
2. Initial installation, installation and removal from cabinets or mounting systems.
3. Operational adjustments covered in the Owner's Manual, normal maintenance, video and audio head cleaning;
4. Damage that occurs in shipment, due to act of God, and cosmetic damage;
5. Signal reception problems and failures due to line power surge;
6. User Removal Memory Devices/Video Pick-up Tubes/CCD Image Sensors are covered for 90 days from the date of purchase;
7. Accessories;
8. Batteries (except that Rechargeable Batteries are covered for 90 days from the date of purchase);
9. Products used for commercial purposes, including, but not limited to rental.
10. Loss of data resultant from malfunction of hard drive or other data storage device;

There are no express warranties except as listed above.

THE DURATION OF ANY IMPLIED WARRANTIES, INCLUDING THE IMPLIED WARRANTY OF MERCHANTABILITY, IS LIMITED TO THE DURATION OF THE EXPRESS WARRANTY HEREIN.

JVC SHALL NOT BE LIABLE FOR ANY LOSS OF USE OF THE PRODUCT, INCONVENIENCE, OR ANY OTHER DAMAGES, WHETHER DIRECT, INCIDENTAL OR CONSEQUENTIAL (INCLUDING, WITHOUT LIMITATION, DAMAGE TO TAPES, RECORDS OR DISCS) RESULTING FROM THE USE OF THIS PRODUCT, OR ARISING OUT OF ANY BREACH OF THIS WARRANTY. ALL EXPRESS AND IMPLIED WARRANTIES, INCLUDING THE WARRANTIES OF MERCHANTABILITY AND FITNESS FOR PARTICULAR PURPOSE, ARE LIMITED TO THE WARRANTY PERIOD SET FORTH ABOVE.

Some states do not allow the exclusion of incidental or consequential damages or limitations on how long an implied warranty lasts, so these limitations or exclusions may not apply to you. This warranty gives you specific legal rights and you may also have other rights which vary from state to state.

**JVC AMERICAS CORP.**

1700 Valley Road, Wayne, New Jersey 07470  
<http://www.jvc.com>

REFURBISHED PRODUCTS CARRY A SEPARATE WARRANTY, THIS WARRANTY DOES NOT APPLY. FOR DETAIL OF REFURBISHED PRODUCT WARRANTY, PLEASE REFER TO THE REFURBISHED PRODUCT WARRANTY INFORMATION PACKAGED WITH EACH REFURBISHED PRODUCT.

**For customer use:**

Enter below the Model No. and Serial No. which is located either on the rear, bottom or side of the cabinet. Retain this information for future reference.

Model No. : \_\_\_\_\_

Serial No. : \_\_\_\_\_

Purchase date : \_\_\_\_\_

Name of dealer : \_\_\_\_\_



JVC Loves the Earth

**JVC COMPANY OF AMERICA**

Division of JVC Americas Corp.

1700 Valley Road

Wayne, New Jersey, 07470

Printed in China

**JVC<sup>®</sup>**

A91N7UH  
1EMN24940 ★★★★★